

SUPPLEMENTAL MEASUREMENT PAYMENT / ITEMS OF
WORK AND CONSTRUCTION DETAILS
FOR
PETERSON WETLAND SITE
IDALS PROJECT NO. HAM892326B
HAMILTON COUNTY, IOWA

BMI PROJECT NO. 0A1.127685

	<p>I hereby certify that this engineering document was prepared by me or under my direct supervision and that I am a duly licensed Professional Engineer under the laws of the State of Iowa.</p> <p>(Signature) _____ (Date) <u>01-22-2026</u></p> <p>Printed or typed name: Brandon C. Short, PE My renewal date is: December 31, 2026 License Number is: 29449 Pages or sheets covered by this seal: Full Document</p>
---	---

CONSTRUCTION SPECIFICATIONS

FOR

HAM892326B Nutrient Reduction Wetland
Hamilton County, Iowa

List of Specifications

<u>Specification Number</u>	<u>Title</u>	<u>Pages</u>
001	SITE PREPARATION	3-4
005	POLLUTION CONTROL	5-6
006	SEEDING AND MULCHING FOR PROTECTIVE COVER	7-10
008	MOBILIZATION AND DEMOBILIZATION	11-12
	STANDARD DETAIL FOR SIGN INSTALLATION	13
009	SUBSURFACE DRAIN INVESTIGATION, REMOVAL, AND REPAIR	14-17
021	EXCAVATION	18-20
023	EARTHFILL	21-24
026	TOPSOIL	25-26
031	CONCRETE	27-33
	FLEXAMAT INSTALLATION DETAIL	34
046	TILE DRAINS FOR LAND DRAINAGE	35-38
061	LOOSE ROCK RIPRAP	39-40

These specifications are part of the construction plans. The work shall be performed in accordance with the drawings and specifications unless otherwise approved, in writing, by the engineer. For items of work requiring engineer inspection, it is the responsibility of the contractor to keep the engineer informed of the progress of work so that timely inspections may be performed. Work installed without engineer inspection will not be certified as meeting NRCS standards. For references to SUDAS, see <https://www.iowasudas.org/manuals/specifications-manual/>

Construction Specification 000 IA CS-00-1 Site Preparation

1. SCOPE

Site preparation work shall consist of clearing, grubbing, stripping, refuse removal, bank sloping and structure removal on the site as necessary to rid the site of all undesirable materials on or near the surface and prepare the site for the structure. All woody growth within the construction area shall be cleared and all stumps and roots one inch in diameter or larger shall be grubbed from the site. In addition, all areas within 25 feet of the footprint of the structure shall be cleared and grubbed except as directed by NRCS. The work shall also consist of the removal and disposal of structures (including fences) that must be removed to perform other items of work.

For wetland restoration, enhancement, or creation projects, the wetland area shall be disturbed as little as possible and existing naturally vegetated spillway areas shall not be disturbed.

2. FOUNDATION PREPARATION

The construction areas shall be stripped a minimum of 6 inches to remove all unsuitable materials such as organic matter, grasses, weeds, sod, debris, and stones larger than 6 inches in diameter.

In an earth embankment foundation area, all channel banks and sharp breaks shall be sloped to no steeper than 1.5 horizontal to 1 vertical.

The foundation area shall be thoroughly scarified before placement of fill material. The surface shall have moisture added or shall be compacted if necessary so that the first layer of fill material can be compacted and bonded to the foundation.

3. STRIPPED MATERIAL DISPOSAL

Suitable soil material shall be stockpiled for use as topsoil. The other stripped materials shall be buried, removed from the site, or disposed of as directed by the owner or NRCS. Whenever possible, material shall not be disposed of in the pool area created by the structure.

Stockpiled materials around a construction site should be placed so as not to hinder subsequent construction operations.

4. DISPOSAL OF REFUSE MATERIALS

Waste materials from clearing and structure removal shall be burned or buried at locations approved by the owner. Buried materials shall be covered with a minimum of 2 feet of earthfill. Whenever possible, material shall not be disposed of in any pool area created by the structure.

All refuse shall be disposed of in a manner which complies with all local and state regulations.

5. SALVAGE

Items to be salvaged shall be as shown on the drawings. Structures and fencing materials that are designated to be salvaged shall be carefully removed and neatly placed in the specified storage areas.

6. SPECIFIC SITE REQUIREMENTS

A. Measurement and Payment

Compensation for any work item described in the contract documents but not listed in the bid schedule will be included in the payment for the item of work to which it is made subsidiary. Such items and bid items to which they are made subsidiary are identified in Items of Work and Construction Details section of this specification.

For items of work which lump sum prices are established in the contract, the quantity of work will not be measured for payment. Payment for each item will be made at the contract lump sum price and will constitute full compensation for completion of the work.

For items of work for which specific unit prices are established in the contract, the payment will be made based on the approved quantity measured by the engineer or weight tickets. Payment will constitute full compensation of the work completed as defined by each work item.

B. Items of Work and Construction Details

1. Bid Item No. 1 – Site Stripping & Preparation

This item will consist of work to remove and dispose of existing vegetation and other unwanted material on areas to be excavated or filled. Total depth of vegetative stripping and topsoil stripping shall equal a combined depth of 12", with the estimated cubic yards of top soil removal as shown in the plans. The topsoil stripping and replacement quantity shall be paid separately.

This item will also include any tree and brush removal along with any fences. These shall be considered incidental to site stripping.

This item will be paid as a lump sum.

2. Bid item No. 2 – Crop Damage

This item consists of crop damage that results from construction activities. It is recommended contractor remove corn residue rather than knock it down.

Payment for crop damage will be made to the nearest 0.1 acre as measured by the Engineer or their representative. The unit rate for crop damage will be determined by the Division near the completion of construction and added to the contract with a Change Order. Payment will be made to contractor who will pay landowner.

Construction Specification 000 IA CS-005 Pollution Control 2011

1. SCOPE

The work shall consist of installing measures or performing work to control erosion and minimize the production of sediment and other pollutants to water and air during construction operations.

2. MATERIALS

All materials furnished shall meet the requirements shown on the drawings or in the specifications.

3. EROSION AND SEDIMENT CONTROL MEASURES AND WORKS

The measures and works shall include, but are not limited to, the following:

Staging of Earthwork Activities: The excavation and moving of soil materials shall be scheduled so that areas unprotected from erosion will be minimized. These areas will be unprotected for the shortest time feasible.

Seeding: Structures and disturbed areas shall be seeded as soon as possible after construction is completed. Temporary seedings may be used as an alternative to other stabilization measures as approved by NRCS.

Mulching: Construction areas that have been disturbed but have no construction activity scheduled for 21 days or more shall have erosion protection measures applied by the 14th day. This erosion protection may be mulching or other approved temporary measures. Construction areas shall not be left open during a winter shutdown period and shall be protected by mulching.

All seeding and mulching shall be completed in accordance with the seeding plan and Iowa Construction Specification IA-6, Seeding and Mulching for Protective Cover.

The following works may be temporary. If they are installed as a temporary measure, they shall be removed and the area restored to its original state when they are no longer needed or when permanent measures are installed.

Diversions: Diversions may be required to divert clean runoff water away from work areas and to collect runoff from work areas for treatment and safe disposition.

Stream Crossings: Culverts or bridges may be required where construction equipment must cross streams.

Sediment Basins: Sediment basins may be required to settle and filter out sediment from eroding areas to protect properties and streams below the construction site.

Sediment Filters: Straw bale filters, geotextile sediment fences, or other equivalent methods may be used to trap sediment from areas of limited runoff. Sediment filters shall be properly anchored to prevent erosion under them.

Waterways: Waterways may be required for the safe removal of runoff from fields, diversions, and other structures or measures

4. CHEMICAL POLLUTION

The Contractor shall provide watertight tanks or barrels or construct a sump sealed with plastic sheets to be used to dispose of chemical pollutants, such as drained lubricating or transmission oils, greases, soaps, concrete mixer wash water, asphalt, etc., produced as a by-product of the construction work.

At the completion of the construction work, sumps shall be removed and the area restored without causing pollution.

Sanitary facilities such as chemical toilets or septic tanks shall not be placed adjacent to live streams, wells, or springs. They shall be located at a distance sufficient to prevent contamination of any water sources. At the completion of construction work, facilities shall be disposed of without causing pollution.

5. AIR POLLUTION

The burning of brush or trash or disposal of other materials shall adhere to local and state regulations.

Fire prevention measures shall be taken to prevent the start or the spreading of wild fires, which result from project work. Fire breaks or guards shall be constructed at locations shown on the drawings.

All public access or haul roads used by the contractor during construction of the project shall be sprinkled or otherwise treated to fully suppress dust. All dust control methods shall ensure safe operations at all times. If chemical dust suppressants are used, the material shall be a commercially available product specifically designed for dust suppression and the application shall follow manufacturer's requirements and recommendations. A copy of the product data sheet and manufacturer's recommended application procedures shall be provided to the Engineer five working days before use.

6. MAINTENANCE, REMOVAL, AND RESTORATION

All pollution control measures and works shall be adequately maintained in a functional condition as long as needed during the construction operation. All temporary measures shall be removed and the site restored to as near original conditions as practical.

7. SPECIFIC SITE REQUIREMENTS

A. Measurement and Payment

Compensation for any work item described in the contract documents but not listed in the bid schedule will be included in the payment for the item of work to which it is made subsidiary. Such items and bid items to which they are made subsidiary are identified in Items of Work and Construction Details section of this specification.

For items of work which lump sum prices are established in the contract, the quantity of work will not be measured for payment. Payment for each item will be made at the contract lump sum price and will constitute full compensation for completion of the work.

For items of work for which specific unit prices are established in the contract, the payment will be made based on the approved quantity measured by the engineer or weight tickets. Payment will constitute full compensation of the work completed as defined by each work item.

B. Items of Work and Construction Details

1. Subsidiary Item - Pollution Control

This item shall consist of applying and performing all construction activities in a manner that will minimize water pollution, air pollution and soil erosion. No separate payment will be made for Pollution Control. Compensation for this item will be other items as appropriate.

Construction Specification 000 IA-6 Seeding and Mulching for Protective Cover

1. SCOPE

The work shall consist of seeding, mulching, and fertilizing all disturbed areas and other areas as indicated on the drawings or otherwise designated.

2. SEEDBED PREPARATION AND APPLICATION

The entire area to be seeded shall be reasonably smooth and all washes and gullies shall be filled to conform to the desired cross-section before actual seedbed preparation is begun. At this stage of the operation, the required fertilizer and lime shall be applied uniformly and incorporated into the top 3 inches of the soil with suitable tillage equipment. The seedbed preparation operation shall be suspended when the soil is too wet or too dry. The seedbed shall be loosened to a depth of at least three inches.

On side slopes steeper than 2-1/2 horizontal to 1 vertical, the 3 inch minimum depth of seedbed preparation is not required, but the soil shall be worked enough to insure sufficient loose soil to provide adequate seed cover.

Unless otherwise specified, the seeding operation shall be performed immediately after preparation of the seedbed. The seed shall be drilled or broadcast by equipment that will insure uniform distribution of the seed.

3. MATERIALS

The seeding, fertilizing, and mulching requirements are as specified on Form IA-CPA-4.

Straw from cereal grains or hay will be used as mulching material. It shall be relatively free of weeds.

4. MULCH APPLICATION

The required mulching shall be performed as soon as possible after seeding unless otherwise specified. The mulch shall be applied uniformly over the area. The type and rate shall be as specified. When mulching is required, all areas seeded during any one day shall be mulched within 24 hours. The mulch may be spread by any means that results in a uniform cover.

The mulch shall be anchored. Anchoring of the mulch may be performed by a mulch anchoring tool or regular farm disk weighted and set nearly straight, by installation of mulch netting, or by other methods approved by NRCS.

5. SPECIFIC SITE REQUIREMENTS

A. Measurement and Payment

Compensation for any work item described in the contract documents but not listed in the bid schedule will be included in the payment for the item of work to which it is made subsidiary. Such items and bid items to which they are made subsidiary are identified in Items of Work and Construction Details section of this specification.

For items of work which lump sum prices are established in the contract, the quantity of work will not be measured for payment. Payment for each item will be made at the contract lump sum price and will constitute full compensation for completion of the work.

For items of work for which specific unit prices are established in the contract, the payment will be made based on the approved quantity measured by the engineer or weight tickets. Payment will constitute full compensation of the work completed as defined by each work item.

B. Items of Work and Construction Details

1. Bid Item No. 3 – Structure & Channel Seeding

This item will consist of seeding the dike except the upstream side slope below the weir elevation, auxiliary spillway, the tile outlet channel side slopes and any other disturbed areas noted on the plans or as determined by engineer.

All seed must be clean and weed free. Seeding rates are expressed in bulk pounds per acre. Seed quality shall not drop below 70% Pure Live Seed (PLS) where PLS = (percent germination plus percent dormant seed) times percent purity.

Seeding rates are as follows:

Smooth Brome grass	25 pounds/acre
--------------------	----------------

Seed shall be applied with a drill and placed at $\frac{1}{4}$ to $\frac{1}{2}$ inch deep.

Fertilizer shall be applied on the entire seeding area at the following rate:

Nitrogen (N)	30 pound/acre
Phosphorus (P ₂ O ₅)	30 pounds/acre
Potassium (K ₂ O)	40 pounds/acre

Straw mulch shall be applied at a rate of 2 tons per acre on all areas receiving structure and channel seeding.

Seeding shall be completed during the following seeding periods:

Spring	March 1 to May 15
Summer	August 1 to September 15
Fall	November 15 to Freeze-up

If construction is completed during any other time of the year, the seeding shall be performed at the next seeding period.

If seeding is completed during the spring seeding period, a companion crop of oats shall be seeded at a rate of 1-1/2 bushels per acre.

Measurement will be based on the areas successfully seeded to the nearest 0.1 acre.

2. Bid Item No. 4 – Buffer Seeding

This item will consist of seeding the areas designated on the plans as buffer seeding and include borrow areas, disturbed areas not seeded as part of structural seeding, and other

areas within the easement. Buffer seeding is not required in area below normal pool elevation established by the weir elevation.

Some areas of the site may have existing CRP vegetation or steep slopes with existing vegetation. Local NRCS personnel will determine if these areas will be included as part of the buffer seeding areas for this project or will be left as is. This may affect the bid quantity and Contractor will verify with Engineer the number of acres that will require buffer seeding.

All seed must be clean and weed free. Seeding rates are expressed in pounds of pure live seed per acre. All seed must be yellow-tagged Iowa ecotype unless approved otherwise by IDALS-DSCWQ.

Seeding mixture shall include a minimum of 5 native grasses and 10 native forbs. The mixture shall provide a minimum of 30 grass seeds per square foot and 10 forbs seeds per square foot. Number of seeds will be based on Iowa Conservation Practice 327 "Native Species for Wildlife". Contractor's proposed seed mix shall be submitted to Engineer and local NRCS office for approval at least 2 weeks before seed is to be applied.

Seeding shall be completed during the following seeding periods:

Spring	April 1 to June 30
Fall	November 15 to Freeze-up

The seed bed shall be properly prepared prior to seeding:

- (a) Any weed control measures shall be completed prior to seeding. If spraying is used, then a span of two weeks shall be allowed between spraying and seeding.
- (b) If the land was in soybeans, no additional tillage is required. If the land was in corn or other vegetation, areas to be seeded shall be disked to thoroughly loosen and pulverize the soil to a depth of 3 inches. This may require multiple passes of equipment. If the land was used for pasture and has a smooth surface, the preparation in non-disturbed areas to be seeded shall include mowing any vegetation taller than 12 inches and applying an appropriate herbicide at the labeled rates to emergent growth 2 to 4 weeks after mowing. After the vegetation has died, the area shall be disked thoroughly loosen and pulverize the soil depth of 3 inches. If emergent growth occurs prior to seeding, the areas shall receive a second application of herbicide. Seeding shall not occur until the existing vegetation has died (about 1 week).
- (c) If deeper disking is used at the site, a lighter disk or spring harrow shall be used to remove deep furrows.
- (d) After disking operations and prior to seed application, the seedbed shall be firmed with a cultipacker or similar piece of equipment.
- (e) No lime or fertilizer is to be applied.

Sow seed with contour using a grassland or rangeland drill set for the specified seeding rates. The drill shall be equipped with double coulter furrow openers. The drill shall be subject to acceptance by Engineer. Overlap each successive seeding pass to ensure complete coverage.

Plant seed not more than 1/4 inch deep; some seed may be seen on the surface after seeding.

Broadcasting by centrifugal-type or hydroseeder broadcasters, or by hand shall be allowed in areas not accessible to drills or other equipment. Once broadcast, the seed must be covered with soil to a depth no greater than 1/4 inch by means of hand rakes or other approved methods.

Upon completion of the seeding operation, cultipack the seedbed to provide a positive seed-soil contact. If the drill seeder is equipped with an approved cultipacker or press wheels, separate operations shall not be necessary. The type of cultipacker/seeder to be used shall be subject to acceptance by Engineer.

No mulch shall be required.

Measurement will be based on the area successfully seeded and measured to the nearest 0.1 acre.

3. Weed Control (Not a Bid item)

Weed control may be needed in portions of this site depending upon the start date of the contract, the initiation of grading, and the seeding dates.

Weed control will be added to the contract with a change order to be negotiated between Contractor and Division based on conditions observed and the type of weed control used and will be paid only once. If delays require additional weed control, this will be paid for at Contractor's own expense.

Weed control may include placement of a cover crop such as oats or rye, spraying with appropriate chemicals, or disking. If thistles are present, only spraying is allowed for weed control and shall include appropriate chemicals designed to control thistles.

**NATURAL RESOURCES CONSERVATION SERVICE
CONSTRUCTION SPECIFICATION**

Construction Specification 8—Mobilization and Demobilization

1. SCOPE

The work consists of the mobilization and demobilization of the contractor's forces and equipment necessary for performing the work required under the contract. It does not include mobilization and demobilization for specific items of work for which payment is provided elsewhere in the contract. Mobilization will not be considered as work in fulfilling the contract requirements for commencement of work.

2. EQUIPMENT AND MATERIAL

Mobilization shall include all activities and associated costs for transportation of contractor's personnel, equipment, and operating supplies to the site; establishment of offices, buildings, and other necessary general facilities for the contractor's operations at the site; premiums paid for performance and payment bonds including coinsurance and reinsurance agreements as applicable; and other items specified in section 4 of this specification.

Demobilization shall include all activities and costs for transportation of personnel, equipment, and supplies not required or included in the contract from the site; including the disassembly, removal, and site cleanup of offices, buildings, and other facilities assembled on the site specifically for this contract.

This work includes mobilization and demobilization required by the contract at the time of award. If additional mobilization and demobilization activities and costs are required during the performance of the contract as a result of changed, deleted, or added items of work for which the contractor is entitled to an adjustment in contract price, compensation for such costs will be included in the price adjustment for the item or items of work changed or added.

3. PAYMENT

Payment will be made as the work proceeds, after presentation of paid invoices or documentation of direct costs by the contractor showing specific mobilization and demobilization costs and supporting evidence of the charges of suppliers, subcontractors, and others. When the total of such payments is less than the lump sum contract price, the balance remaining will be included in the final contract payment. Payment of the lump sum contract price for mobilization and demobilization will constitute full compensation for completion of the work.

Payment will not be made under this item for the purchase costs of materials having a residual value, the purchase costs of materials to be incorporated in the project, or the purchase costs of operating supplies.

4. ITEMS OF WORK AND CONSTRUCTION DETAILS

A. Measurement and Payment

Compensation for any work item described in the contract documents but not listed in the bid schedule will be included in the payment for the item of work to which it is made subsidiary. Such items and bid items to which they are made subsidiary are identified in Items of Work and Construction Details section of this specification.

For items of work which lump sum prices are established in the contract, the quantity of work will not be measured for payment. Payment for each item will be made at the contract lump sum price and will constitute full compensation for completion of the work.

For items of work for which specific unit prices are established in the contract, the payment will be made based on the approved quantity measured by the engineer or weight tickets. Payment will constitute full compensation of the work completed as defined by each work item.

B. Items of Work and Construction Details

1. Bid Item No. 5 – Mobilization and Demobilization

This item shall consist of mobilizing and demobilizing personnel and equipment in preparation to perform the work within the scope of this contract.

Any work that is necessary to provide access to the site including, but not limited to, grading, temporary culverts, and clearing will be included in this item. When construction is completed access areas will be restored, as close as practical, to its original condition.

Any fence removed for access and /or to provide work area shall be replaced with same or like materials as approved by the engineer.

The Contractor shall exercise caution to minimize the amount of damage caused by the grading and clearing operations.

Portable toilets shall be provided at the construction site and used for the sanitary facilities.

This item shall not include transportation of personnel, equipment and operating supplies within the work limits areas of this contract.

Payment will constitute full compensation for related subsidiary item, Pollution Control.

Payment will be made as the work proceeds and will be paid out on the percent of the project complete as the work progresses. Payment of the lump sum contract price for mobilization and demobilization will constitute full compensation for the completion of the work.

Contractor is to contact "Iowa One Call" for utility locations a minimum of two (2) days prior to any excavation/construction. The ticket number must be provided to Engineer.

2. Subsidiary Item – Sign Installation

This item shall include all labor, materials, equipment and Iowa One Call notifications to install sign provided by Iowa Department of Agriculture and Land Stewardship, as shown on the plans or on next page.

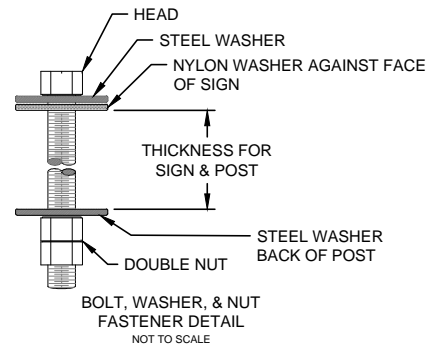
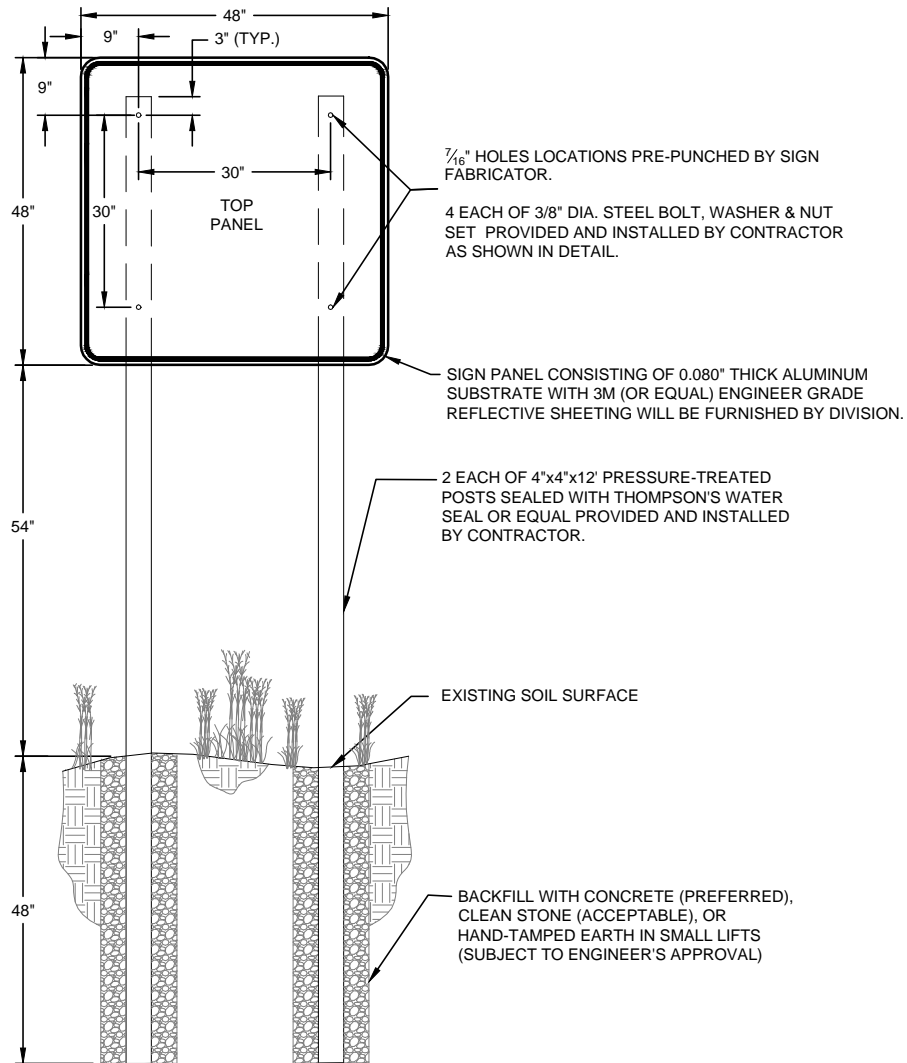

SIGNAGE NOTES:

1. DIVISION WILL FURNISH SIGN PANEL. CONTRACTOR IS RESPONSIBLE FOR PROVIDING POSTS, HARDWARE, AND INSTALLATION .
2. ALL EXPOSED WOOD SHALL BE SEALED WITH THOMPSON'S WATER SEAL OR EQUAL MEETING ASTM D-4446-08.
3. ALL STEEL HARDWARE PIECES SHALL BE GALVANIZED OR RUST RESISTANT.
4. NYLON AND STEEL WASHERS SHALL BE USED AS SHOWN ON THE BOLT, WASHER, NUT FASTENER DETAIL ABOVE.
5. CLEAR UTILITIES WITH IOWA ONE-CALL AT 811 OR (800) 292-8989 BEFORE EXCAVATING FOR POSTS.
6. SECURE DIVISION AND LANDOWNERS APPROVAL FOR SIGN LOCATION BEFORE INSTALLATION.
7. COSTS FOR POSTS, HARDWARE, WOOD SEALANT AND SIGN INSTALLATION SHALL BE INCIDENTAL TO MOBILIZATION.
8. CONTRACTOR SHALL INSTALL SIGN POSTS USING A PLYWOOD OR OTHER SUITABLE TEMPLATE TO MAINTAIN ACCURATE POST SPACING AND ALIGNMENT DURING BACKFILLING OF THE POST HOLES. TO AVOID BENDING OF THE SIGN PANELS, POSTS SHALL NOT BE INSTALLED OR BACKFILLED WITH SIGN PANELS ATTACHED.
9. ONE (1) PROJECT SIGN SHALL BE INSTALLED UNLESS NOTED OTHERWISE.

STANDARD DETAIL FOR SIGN INSTALLATION
DIVISION OF SOIL CONSERVATION AND WATER QUALITY

NATURAL RESOURCES CONSERVATION SERVICE CONSTRUCTION SPECIFICATION

IA-9 SUBSURFACE DRAIN INVESTIGATION, REMOVAL, AND REPAIR

1. SCOPE

The work shall consist of investigation, location, repair, and/or removal of subsurface drains (tile) near new or existing animal waste storage facilities or in wetland restoration, enhancement, or creation project areas, or other situations where subsurface drains may be present.

2. INVESTIGATION AND LOCATION

An inspection trench at least 10 inches wide shall be dug at the location shown on the drawings or as directed by the engineer or his representative. The trench shall be at least 6 feet deep measured from the original ground line, unless otherwise shown on the plans. The Engineer or his representative shall examine the trench and excavated material to identify tile lines.

Size, material, operating condition and direction of flow of each conduit shall be documented. Location and flow line elevation of each conduit shall be surveyed with horizontal and vertical control based on benchmarks shown on the plans.

The inspection trench shall be documented by surveying the natural ground and trench bottom location and elevations at the beginning, end, and every 50 feet for trenches longer than 50 feet.

Backfilling shall not be started without approval of the Engineer. See Section 5 for backfill specifications.

Trench shields, shoring and bracing, or other methods necessary to safeguard the workers and work, and to prevent damage to the existing improvements shall be furnished, placed, and subsequently removed by the contractor.

3. TILE REPAIR

Unless designated for removal, replace damaged conduit with new conduit having equal or greater capacity using material specified in Section 6 or 7. When replacing short sections of clay or concrete tile with single-wall corrugated polyethylene pipe, use the next larger nominal size.

Make connections with manufactured fittings and tight joints. Where joints have gaps that would allow soil to enter, cover the joint with a permanent type material such as coal tar pitch treated roofing paper, fiber glass sheet or mat, or plastic sheet.

If the investigation trench has been excavated below the existing drain grade, backfill the trench with gravel or well-pulverized soil in layers not over four (4) inches thick and tamp by hand or manually directed power tamper to provide a firm foundation for the conduit at the existing grade. Do not backfill with any soil containing broken tile fragments.

Using selected soil free of hard clods, rocks, or frozen soil, hand tamp the backfill material around the haunch of the pipe in layers not over four (4) inches thick to provide support. Hold the conduit in place

mechanically while placing excavated material around and over the conduit to ensure proper alignment and grade is maintained. Complete the backfill operation according to Section 5.

4. TILE REMOVAL

Remove conduits as shown on the plans or directed by the Engineer or his representative, including envelope filter material or other flow enhancing material when present.

Cap or plug the open ends of the disconnected conduit to prevent soil entry when the conduit will continue to function downstream, or otherwise shown on the plans. For a minimum distance of two feet around each sealed conduit end, backfill in layers not over four (4) inches thick and tamp by hand or manually directed power tamper to a density equal to or greater than the surrounding undisturbed soil. Do not backfill with any soil containing broken tile fragments, large stones, frozen material, or large dry clods.

Where tile are located beneath an existing animal waste facility, remove the tile or fill the entire length of tile with concrete or Portland cement grout as shown on the plans. When tile removal is specified, the owner shall contact the Iowa Department of Natural Resources (IDNR) for permission to remove the drainage tile under the structure. The structure shall be emptied of waste or lowered to a point below the tile prior to its removal. The structure must be retested for percolation and the results submitted to IDNR and approval received prior to reusing the structure.

If shown on the plans or directed by the engineer, reroute upstream drain lines so the capacity of the upstream drainage system is maintained. Install conduit in accordance with Iowa Construction Specification IA-46, Tile Drains for Land Drainage.

5. BACKFILL

Compact soil around disturbed tile as specified in Section 3 (Tile Repair) and Section 4 (Tile Removal). Keep the backfill within 5 feet of the conduit free from large stones, frozen material, and large dry clods. Unless otherwise shown on the plans, backfill the remainder of the trench as follows:

For trenches located under or near structures, backfill in 12-inch layers and compact each layer to a density equal to or greater than the surrounding undisturbed soil.

For other locations, backfill the remainder of each trench with the excavated soil material which shall extend above the ground surface and be well rounded over the trench.

6. MATERIALS

Unless otherwise shown on the plans, conduit and fittings used for repair shall conform to the specifications listed in Table 1. Perforated pipe shall have a water inlet area of at least 1 square inch per foot, provided by perforations spaced uniformly along the long axis of the pipe. The perforations shall be circular or slots. Circular perforations shall not exceed 3/16 inch in diameter. Slots shall not be more than 1/8 inch wide.

Table 1. Acceptable pipe for subsurface drain repair

Kind of Pipe[#]	Specification
Corrugated Polyethylene (PE) Pipe and Fittings, 3 to 6 inch	ASTM F 405
Corrugated Polyethylene (PE) Pipe and Fittings, 3 to 24 inch	ASTM F 667
Corrugated Profile Wall (Dual Wall) Polyethylene (PE) pipe, 2 to 60 inch	ASTM F 2648 [§]
Corrugated Profile Wall (Dual Wall) Polyethylene (PE) pipe, 12 to 60 inch	ASTM F 2306 [§]
Polyvinyl Chloride (PVC) Plastic Pipe, Schedules 40, 80 and 120	ASTM D 1785
PVC Pressure-Rated Pipe (SDR Series)	ASTM D 2241
Clay drain tile	ASTM C 4
Concrete drain tile	ASTM C 412

[#]Pipe sizes are nominal and the ranges are inclusive

[§]Pipe conforming to AASHTO M 252 (3 to 10 inch), or AASHTO M 294 (12 to 60 inch) is acceptable.

7. SPECIFIC SITE REQUIREMENTS

A. Measurement and Payment

Compensation for any work item described in the contract documents but not listed in the bid schedule will be included in the payment for the item of work to which it is made subsidiary. Such items and bid items to which they are made subsidiary are identified in Items of Work and Construction Details section of this specification.

For items of work which lump sum prices are established in the contract, the quantity of work will not be measured for payment. Payment for each item will be made at the contract lump sum price and will constitute full compensation for completion of the work.

For items of work for which specific unit prices are established in the contract, the payment will be made based on the approved quantity measured by the engineer or weight tickets. Payment will constitute full compensation of the work completed as defined by each work item.

B. Items of Work and Construction Details

1. Bid Item No. 6 – Drain Tile Investigation and Removal

This item will consist of the excavation necessary to locate and remove all tile under the embankment and to locate and determine the tie-in locations for the tile locations shown on the plans. This item shall also include backfilling of the trenches.

This item does not include the additional excavation required to excavate the embankment core trench, if included in the project. Excavation of the core trench is covered under Specification IA-21, Excavation.

The extent of the tile investigation shall be as shown on the drawings. If extra work is required to locate additional tile not shown on the drawings, the Contractor can request additional compensation, but it must be first approved by the Division.

The investigation should reveal where the tile crosses the embankment footprint or where it is located if it does not cross the embankment footprint

Payment for Drainage Tile Investigation and removal shall be made on an hourly basis. The Contractor shall notify the engineer when tile investigation is being performed.

Construction Specification 000 IA-21 Excavation

1. SCOPE

The work shall consist of the excavation required by the drawings and specifications and disposal of the excavated materials. The cutoff trench and any other required excavations shall be dug to the lines and grades shown on the drawings or as staked in the field. Structure or trench excavations will conform to all safety requirements of OSHA.

2. USE OF EXCAVATED MATERIALS

Suitable materials from the specified excavations shall be used in the construction of required permanent earth fill. The suitability of materials for specific purposes shall be determined by the NRCS Inspector.

3. DISPOSAL OF WASTE MATERIAL

All surplus or waste material shall be disposed of in areas shown on the drawings or as approved by the NRCS Inspector. The waste material shall be smoothed and sloped to provide drainage.

4. STRUCTURE AND TRENCH EXCAVATION

Structure or trench excavations will conform to all safety requirements of OSHA.

5. BORROW EXCAVATION

When the quantities of suitable materials obtained from specified excavations are insufficient to construct the specified fills, additional materials shall be obtained from the designated borrow areas as shown on the drawings or as approved by NRCS and the landowner. On wetland projects, borrow shall not be taken from the wetland area within 10 feet of the embankment or as shown on the drawings.

Borrow areas shall be excavated and grading completed in a manner to eliminate steep or unstable side slopes or hazardous or unsightly conditions.

6. OVER-EXCAVATION

Excavation beyond the specified lines and grades shall be corrected by filling the resulting voids with compacted earthfill, except that if the earth is to become the subgrade for riprap, sand or gravel bedding or drainfill, the voids shall be filled with material conforming to the specifications for the riprap, bedding or drainfill, as appropriate.

7. SPECIFIC SITE REQUIREMENTS

A. Measurement and Payment

Compensation for any work item described in the contract documents but not listed in the bid schedule will be included in the payment for the item of work to which it is made subsidiary. Such items and bid items to which they are made subsidiary are identified in Items of Work and Construction Details section of this specification.

For items of work which lump sum prices are established in the contract, the quantity of work will not be measured for payment. Payment for each item will be made at the contract lump sum price and will constitute full compensation for completion of the work.

For items of work for which specific unit prices are established in the contract, the payment will be made based on the approved quantity measured by the engineer or weight tickets. Payment will constitute full compensation of the work completed as defined by each work item.

The volume of excavation as provided in the bid quantities has been determined from the topographic information shown on the Drawings using a computer program. Payment will be made based on the planned quantities provided unless additional excavation is directed by the Engineer. Excavation resulting from the contractor's improper construction operations, as determined by the Engineer, is not included for measurement and payment.

B. Items of Work and Construction Details

1. Bid Item No. 7 – Excavation (General)

This item will consist of excavation and grading of material needed for the following typical items as shown in the plans:

- Establishing pool final grade
- Inlet channel
- Connection channel

Excavations required for tile exploration, new tile installation, riprap placement, are not included in this bid quantity and will not be measured for payment. The cost of excavation for these items are incidental and should be included as part of their corresponding bid items.

This item does not include the excavation for site stripping or topsoil, which is covered under Specification IA-CS-001. "Site Preparation".

This item includes the hauling of excavated material to be used as earthfill or spoil.

The material excavated with suitable quality shall be used for the diversion berm and separation berm as directed by engineer.

Excavated material not to be used in the diversion berm or separation berm shall be placed in the spoil pile as shown on the plans. See IA CS-023 for placement details.

See Specification IA-CS-023 for compaction method.

Payment will be based on plan quantity. Plan quantity includes all excavation, is based on neat lines and does not include a shrink/swell factor. If unsuitable material is found at the bottom of the core trench, the over excavation shall be measured and paid in a change order.

Payment will constitute full compensation for the following related Subsidiary items: Pollution Control; Removal of Water; and Structure Excavation.

2. Subsidiary Item – Structure Excavation

This item shall consist of the excavation necessary to install the steel sheet pile, riprap, corrugated metal pipe (CMP) conduit, CMP tile outlets and water control structure in the locations and as shown on the drawings.

No separate payment will be made for Structure Excavation. Compensation for this item will be included in payment with the corresponding bid items for CMP conduit; CMP water control structure; steel sheet pile; and riprap.

3. Subsidiary Item – Temporary Channel

This item shall consist of the excavation necessary for the temporary channel in the location and as shown on the drawings.

No separate payment will be made for Temporary Channel. Compensation for this item will be included in payment with the corresponding bid items for general excavation.

Construction Specification 000 IA-23 Earthfill

1. SCOPE

The work shall consist of the construction of earth fills required by the drawings and specifications. The completed work shall conform to the lines, grades, and elevations shown on the drawings or as staked in the field.

2. MATERIALS

All fill materials shall be obtained from required excavations and designated borrow areas. Fill materials shall contain no sod, brush, roots or other bio-degradable materials. Rocks larger than 6 inches in diameter shall be removed prior to compaction of the fill.

3. FOUNDATION PREPARATION

Foundations for earthfill shall be stripped a minimum of 6 inches to remove vegetation and other unsuitable materials. Foundation surfaces shall be scarified to a minimum depth of 2 inches prior to placing fill material.

Foundation and abutment surfaces shall not be sloped steeper than 1.5 horizontal to 1 vertical unless otherwise shown on the drawings.

4. PLACEMENT

Fill shall not be placed until the required excavation and foundation preparation have been completed and the foundation has been inspected and approved by NRCS. Fill shall not be placed upon a frozen surface, nor shall snow, ice, or frozen material be incorporated in the fill.

Adjacent to structures or pipes, fill shall be placed in a manner which will prevent damage. The height of the fill adjacent to structures or pipes shall be increased at approximately the same rate on all sides.

The materials used throughout the earthfill shall be essentially uniform. Selective placement shall be as shown on the drawings or approved by NRCS.

If the surface of any layer becomes too hard and smooth for proper bond with the succeeding layer, it shall be scarified to a minimum depth of 2 inches before the next layer is placed.

The top surfaces of embankments shall be maintained approximately level during construction, except that a cross-slope of approximately 2% shall be maintained to ensure effective drainage.

When moving fill material from the borrow area(s) to the embankment by use of bulldozers only, the following steps shall be followed:

- Immediately after the borrow material is pushed to the embankment, it shall be spread in horizontal lifts placed parallel to the centerline of the embankment.
- Compactive effort will then be applied by operating equipment parallel to the centerline of the fill or embankment.
- Lift thicknesses shall be in strict compliance with Clause 6, below.

Sectional fills are not allowed unless they are shown on the construction drawings.

5. CONTROL OF MOISTURE CONTENT

The moisture content of the fill material shall be adequate for obtaining the required compaction. Material that is too wet shall be dried to meet this requirement, and material that is too dry shall have water added and mixed until the requirement is met.

The moisture content of the fill material shall be such that a ball formed with the hands does not crack or separate when struck sharply with a pencil and will easily ribbon out between the thumb and finger.

Earth foundations under and adjacent to concrete structures shall be prevented from drying and cracking before concrete and backfill are placed.

The application of water to the fill materials shall be accomplished at the borrow areas insofar as possible.

6. COMPACTION

Earth fill shall be compacted by one of the following methods as specified on the plans or in Section 8, Special Specifications. If no method is specified, compaction will be in accordance with Method 1.

- Method 1 - Earthfill shall be placed so that the wheels or tracks of the loaded hauling equipment, traveling in a direction parallel to the centerline of fill, pass over the entire surface of each layer being placed. Low ground pressure vehicles shall not be used for this purpose.
- Method 2 - Two (2) complete passes of a tamping-type roller will be made over each layer. The roller shall be capable of exerting a minimum force of two hundred (200) pounds per square inch.
- Method 3 - Minimum density shall be 90% of the maximum density as determined by ASTM D 698 and as shown on the plans.

The maximum thickness of a lift of fill before compaction shall be 9 inches, unless otherwise indicated on the drawings.

Fill adjacent to structures, pipe conduits, and appurtenances shall be placed in layers not more than 4 inches thick and compacted to a density equivalent to that of the surrounding fill. Methods used to obtain compaction for fine or coarse grained materials are as follows:

- For fine grained materials, hand tamping or manually directed power tampers may be used. Hand compaction only shall be used to compact the earthfill under the bottom half of circular pipes. Manually directed power tampers shall not be used in tight spaces where applying full compactive effort will result in direct contact of the tamper plate with the pipe. Care should be taken so that compaction around the spillway pipe does not cause uplift of the pipe resulting in a void beneath the pipe.
- For coarse grained materials (sands and gravels), vibratory plate compactors shall be used for obtaining compaction. However, hand tamping shall be used to compact the material under the bottom half of circular pipes.

In all cases, follow manufacturer instructions for the specific compaction equipment being used. Heavy equipment shall not be operated within 2 feet of any structure or pipe.

Compacting of fill adjacent to concrete structures shall not be started until the concrete is 7 days old.

7. ISLANDS, MOUNDS, AND LOAFING AREAS ON WETLAND RESTORATION, ENHANCEMENT, OR CREATION PROJECTS

Islands shall be randomly located within the wetland area at locations shown on the drawings or as staked in the field. The orientation of island shorelines shall be random with attention given to prevailing

winds to limit wave damage. In general, the side of the island with the longest dimension shall be parallel to the prevailing wind direction. Side slopes of islands shall be as shown on the drawings, but in no case shall be steeper than 6 horizontal to 1 vertical. Island shapes shall be irregular.

Loafing areas shall be constructed in the areas shown on the drawings or as staked in the field and shall be graded to drain runoff water. The elevation of at least one loafing area should be above the maximum water level whenever possible.

Excavated material not suitable for embankments, wetland dikes, or islands can be used to create mounds or blended into surrounding topography to create a natural appearance. Spoil material shall not be spread on existing wetland areas.

Organic soils shall not be used to construct islands, loafing areas, dikes, or embankments.

8. SPECIFIC SITE REQUIREMENTS

A. Measurement and Payment

For items of work which specific unit prices are established in the contract, the volume of earthfill will be computed to the nearest cubic yard by the method of average cross-sectional end areas. No deduction in volume will be made for embedded items, such as, conduits inlet structures and their appurtenances. The pay limits for computation shall be as shown on the drawings with the further provisions that earthfill voids resulting from over excavation of the foundation, outside specified lines and grades, will be included in the measurement for payment only under the following conditions:

- Where such over excavation is directed by the engineer to remove unsuitable material, and
- Where the unsuitable condition is not a result of the contractor's improper construction operations as determined by the engineer.

Earthfill beyond the specified lines and grades to backfill excavation required for compliance with OSHA requirements will be considered subsidiary to the earthfill bid item(s).

Payment for each type and compaction class of earthfill and earth backfill is made at the contract unit price for that type and compaction class of earthfill. Such payment will constitute full compensation for all labor, material, equipment, and all other items necessary and incidental to the performance of the work.

Compensation for any item of work described in the contract, but not listed in the bid schedule is included in the payment for the item of work to which it is made subsidiary. Such items and the items to which they are made subsidiary are identified in this specific section.

B. Items of Work and Construction Details

Items of work to be performed in conformance with this specification and the construction details therefore are:

1. Bid Item No. 8 – Earthfill (General)

This item shall consist of the earthfill necessary to construct the cover and separation berms and additional fill to be placed over the tile to provide adequate cover. Cohesive material found during general grading and compacted liner removal can be used for these areas. Sand and gravel found on site shall not be used for this earthfill.

Compaction shall be Method 1. Rocks larger than 6" shall be removed prior to compaction.

Payment for these items shall be based on plan quantity unless additional length or location of tile varies from what is shown on the plans. The plan quantity is based on neat lines and does not account for any shrinkage.

Payment will constitute full compensation for the following related Subsidiary items: Pollution Control, Removal of Water, and Backfill Required Excavation.

2. Subsidiary Item – Backfill Required Excavation

This item shall consist of backfilling the areas excavated to install the other components related to the project such as piping or structures and to locate and remove the tile lines.

Compaction adjacent to the structures shall be as indicated above. All other compaction shall be Method 1 or equivalent.

No separate payment will be made for Backfill of Structure Excavation. Compensation for this item will be included in payment for Corrugated Metal Pipe; CMP Drawdown Structure; Riser Inlet Structure, Tile Investigation and Removal and Dual Wall HDPE.

3. Subsidiary Item – Spoil Haul and Placement

This item shall consist of hauling and placing excavated spoils from the wetland pool in the spoil pile location shown on the plans. The spoil shall be placed in a manner that minimizes the area of the spoil pile. Spoil pile shall have slopes of no steeper than 3:1. Compaction shall be method 1. No separate payment shall be made for this item. Payment shall be subsidiary to Bid Item No. 7.

Construction Specification 000 IA-26 Topsoiling

1. SCOPE

The work shall consist of salvaging topsoil from borrow areas or required excavations and spreading it on the exposed disturbed areas.

2. QUALITY OF TOPSOIL

Topsoil shall consist of friable surface soil reasonably free of grass, roots, weeds, sticks, stones, or other foreign materials.

3. EXCAVATION

After the site has been cleared and grubbed, the topsoil shall be removed from borrow areas and required excavation areas to the depth as shown on the drawings. Topsoil shall be stockpiled at locations approved by NRCS.

4. SPREADING

Spreading shall not be done when the ground or topsoil is frozen, excessively wet, or otherwise in a condition detrimental to the work. Surfaces designated to be covered shall be lightly scarified just prior to the spreading operation. Where compacted fills are designated to be covered by topsoil, the topsoil shall be placed concurrently with the fill and shall be bonded to the compacted fill with the equipment.

Topsoil shall be placed to the minimum depth shown on the drawings. After the spreading operation is completed, the surface shall be finished to a reasonably smooth surface.

5. SPECIFIC SITE REQUIREMENTS

A. Measurement and Payment

Compensation for any work item described in the contract documents but not listed in the bid schedule will be included in the payment for the item of work to which it is made subsidiary. Such items and bid items to which they are made subsidiary are identified in Items of Work and Construction Details section of this specification.

For items of work which lump sum prices are established in the contract, the quantity of work will not be measured for payment. Payment for each item will be made at the contract lump sum price and will constitute full compensation for completion of the work.

For items of work for which specific unit prices are established in the contract, the payment will be made based on the approved quantity measured by the engineer or weight tickets. Payment will constitute full compensation of the work completed as defined by each work item.

B. Items of Work and Construction Details

1. Subsidiary Item – Topsoil Strip, Salvage, and Respread

It is that the existing depth of topsoil is greater than the depth of cut within the wetland and as such topsoiling will not be required. Where less than 6" of topsoil remains below the excavated surface, topsoil shall be replaced to a depth of 6". This shall be subsidiary to the Excavation (General) bid item.

Areas to receive a minimum of 6-inch layer of topsoil include areas of the embankment that do not have riprap, additional fill placed over new tile, and any other areas noted in the plans.

Grading areas with at least 6 inches of topsoil remaining will not require topsoil respreading unless required by engineer.

Payment will constitute full compensation for the following related subsidiary items: Site Preparation and Pollution Control.

Construction Specification 000 IA-31 Concrete

1. SCOPE

The work shall consist of furnishing, forming, placing, finishing, and curing Portland cement concrete including steel reinforcement.

2. MATERIALS

Portland Cement shall conform to ASTM C 150 and shall be Type I or Type II.

Fine Aggregates shall conform to ASTM C 33 and shall be composed of clean, uncoated grains of material.

Coarse Aggregates shall be gravel or crushed stone conforming to ASTM C 33 and shall be clean, hard, durable and free from clay or coating of any character. The maximum size of coarse aggregate shall be 1/2 inches or as shown on the drawings.

Water shall be clean and free from injurious amounts of oil, acid, salt, alkali, organic matter, or other deleterious substances.

Air entraining agent shall conform to ASTM C 260.

Fly ash may be used as a partial substitution for Portland cement and shall be in strict compliance with ASTM C 618, Class F or C. The loss by ignition shall not exceed 4.0 percent.

Blast-furnace slag may be used as a partial substitution for Portland cement and shall be in conformance with ASTM C 989 for ground granulated blast-furnace slag (GGBF slag).

Water-reducing admixtures shall conform to ASTM C 494 and may be the following types:

1. Type A - Water-reducing admixture
2. Type D - Water-reducing and retarding admixture
3. Type F - Water-reducing, high range admixture (superplasticizer).
4. Type G - water-reducing, high range, and retarding admixture (superplasticizer).

Type D or G admixture may be used when the air temperature is over 80 degrees F. at the time of mixing and/or placement.

Calcium Chloride or other antifreeze compounds or accelerators will not be allowed.

Preformed expansion joint filler shall be a commercially available product made of bituminous, sponge rubber or closed cell foam materials with a minimum thickness of 1/2 inch.

Reinforcing steel shall be free from loose rust, oil, grease, paint, or other deleterious matter. Reinforcing steel shall conform to one or more of the following:

1. Reinforcing Bars - ASTM A 615 or A 996, Grade 40 or greater, deformed.
2. Welded Wire Fabric - ASTM A 185 or A 497.

Waterstops shall be either metallic or nonmetallic. Metallic waterstops shall be fabricated from sheets of copper or galvanized steel. Nonmetallic waterstops shall be made of natural or synthetic rubber or vinyl chloride polymer or copolymer. Rubber, polymer and copolymer waterstops shall have ribbed or bulb-type

anchor flanges and a hollow tubular center bulb, unless otherwise shown on the drawings. All waterstops shall be of the sizes shown on the drawings.

Curing compound shall be a liquid membrane-forming compound suitable for spraying on the concrete surface. The curing compound shall meet the requirements of ASTM C 309 Type 2 (white pigmented).

3. CONCRETE DESIGN MIX

The contractor will be responsible for the determining the design mix proportions in accordance with the requirements included in this paragraph and shall provide a copy of the mix to the NRCS Engineer at Natural Resources Conservation Service least 3 days prior to placing any concrete. The concrete mix shall be of such proportions as to provide a minimum strength of 3500 p.s.i. in 28 days, unless otherwise shown on the drawings. The air content shall be 4 to 8 percent of the volume of the concrete at the time of placement. The slump shall be 2 to 5 inches except when superplasticizer is used. The slump shall be 3 inches or less prior to the addition of superplasticizer admixture and shall not exceed 7 1/2 inches following addition and mixing. The fine aggregate shall be 30-50 percent of the total combined aggregate based on oven dry weights. The contractor shall provide tests to verify that the design mix meets the requirements. In lieu of this, one of the following mix proportions per cubic yard may be used:

Mix Number	Minimum Cement, Pounds	Fly Ash, Pounds	GGBF Slag, Pounds	Maximum **Water, Gallons
1	564	0	0	33
2	470	45-90	0	31-34
3	517	129	0	31*
4	366	114	91	31*
5	259	103	155	31*

** Total of available aggregate moisture, mixing water added at the plant and mixing water added at the job site (one gallon equals 8.33 pounds).
 * Requires water reducing admixture.

4. MIXTURES AND MIXING

Ready-mixed concrete shall be batched, mixed and transported in accordance with ASTM C 94. Concrete shall be uniform and thoroughly mixed when delivered to the forms. No mixing water in excess of the amount shown for the design mix or in an amount that would cause the maximum slump to be exceeded shall be added to the concrete during mixing, hauling or after arrival at the point of delivery. The concrete shall be batched and mixed so that the temperature of the concrete at the time of placing shall be between 50 and 90 degrees F.

5. BATCH TICKET

The contractor shall obtain from the supplier a delivery ticket for each batch of concrete before unloading at the site. The following information shall be included on the ticket: name of concrete supplier, job name or location, date, truck number, amount of concrete, time loaded or time of first mixing cement, aggregate, and mixing water added at the plant, type and amount of cement, type and amount of admixtures, oven dry weights of fine and coarse aggregate, and moisture content(%) or weight of water contained in the aggregates.

The following information shall be added to the batch ticket on site: mixing water added on site, time concrete arrived on site and time concrete was unloaded.

Upon completion of the concrete placement, copies of all batch tickets shall be provided to NRCS.

6. REINFORCING STEEL

Before reinforcement is placed, the surfaces of the bars or mesh shall be cleaned to remove any loose, flaky rust, mill scale, oil, grease, or other foreign substances. After placement, the reinforcement shall be maintained in a clean condition until it is completely embedded in the concrete.

Reinforcing bars shall be cut and bent according to ACI Standard 315.

Tack welding of bars shall not be permitted. Reinforcement shall be accurately placed as shown on the drawings and secured in position in a manner that will prevent its displacement during placement of concrete. Metal chairs, metal hangers, metal spacers or concrete chairs shall be used to support reinforcement. Precast concrete chairs shall be manufactured from concrete equal in quality to the concrete being placed. Precast concrete chairs shall be moist at the time concrete is placed

Splices of reinforcing bars shall be made only at the locations shown on the drawings, unless otherwise approved by the NRCS Engineer. All reinforcing splices and placement shall be in accordance with ACI 318 and as shown on the drawings.

After placement of the reinforcement, concrete shall not be placed until the reinforcement has been inspected and approved by NRCS.

7. PREPARATION OF FORMS AND SUBGRADE

Prior to placement of concrete, the forms and subgrade shall be free of woodchips, sawdust, debris, water, ice, snow, extraneous oil, mortar, or other harmful substances or coatings. Any oil on the reinforcing steel or other surfaces required to be bonded to the concrete shall be removed. All surfaces shall be firm and damp prior to placing concrete. Placement of concrete on mud, dried earth, uncompacted fill, or frozen subgrade will not be permitted.

The forms and associated false-work shall be substantial and unyielding and shall be constructed so that the finished concrete will conform to the specified dimensions and elevations. Forms will be mortar tight. Forms with torn surfaces, worn edges, dents or other defects will not be used. Forms shall be coated with a nonstaining form release agent before being set into place. Excess form coating material shall not stand in puddles in the forms or come in contact with the steel reinforcement or hardened concrete against which fresh concrete is to be placed.

Form accessories to be partially or wholly embedded in the concrete, such as ties and hangers, shall be of a commercially manufactured type. Non fabricated wire shall not be used. Form ties shall be constructed so that the ends or end fasteners can be removed without causing spalling at the surface of the concrete.

Metal form ties used within the forms on structures with a total volume of concrete exceeding fifteen cubic yards shall be equipped with cones or other devices that permit their removal to a depth of at least one inch without damage to the concrete. The holes resulting from cones and other devices shall be patched in accordance with Section 9.

Form ties except those specifically covered by the preceding paragraph shall be broken off flush with the formed surface. Any surface areas which have been spalled or otherwise damaged shall be repaired in accordance with Section 9.

Steel tying and form construction adjacent to new concrete shall not be started until concrete has cured at least 12 hours.

Concrete joints shall be of the type and at the locations shown on the drawings. Splices in metal waterstops shall be brazed, welded or overlapped and bolted.

Splices in nonmetallic waterstops shall be cemented or joined as recommended by the manufacturer.

8. PLACING CONCRETE

Concrete shall not be placed until the subgrade, forms, and steel reinforcement have been inspected and approved by the NRCS Inspector. Any deficiencies are to be corrected before the concrete is delivered for placement.

Concrete shall be delivered to the site and discharged into the forms within 1 1/2 hours after the introduction of the cement to the aggregates. When a superplasticizer is used, the concrete shall be discharged within the manufacturer's recommended time limit for discharge after addition of the admixture. In hot weather or under conditions contributing to quick setup of the concrete, discharge of the concrete shall be accomplished in 45 minutes unless a set-retarding admixture is used, in which case the manufacturer's recommended time limit will apply.

Addition of water at the job site may be done at the beginning of placement of each load of concrete in order to obtain allowable slump, provided that the maximum water content and water/cement ratio in the design mix is not exceeded. Addition of water will not be permitted after placement of the load has started.

The concrete shall be deposited as closely as possible to its final position in the forms and shall be worked into corners and around reinforcement and other embedded items in a manner which prevents segregation. Formed concrete shall be deposited in layers 24 inches or less in depth and shall be continuously deposited so that no concrete will be deposited on concrete which has hardened sufficiently to cause the formation of "cold joints". Concrete containing superplasticizer shall be placed in lifts not exceeding 5 feet in depth. If the surface layer of concrete sets during placement to the degree that it will not flow and merge with the succeeding layer when tamped or vibrated, the contractor shall discontinue placing concrete and install a construction joint. Construction joints shall be completed as shown on the drawings or by one of the following methods:

1. The joint shall be constructed using a 6 inch wide by 1/4 inch steel plate. The surfaces of the construction joint shall be prepared by washing and scrubbing with a wire brush or wire broom to expose coarse aggregate. The steel plate shall be embedded 3" in the concrete.
2. The joint surface shall be cleaned to expose coarse aggregate by sandblasting or air-water cutting after the concrete has gained sufficient strength to prevent displacement of the coarse aggregate or cement fines. The surface of the concrete shall not be cut so deep as to undercut the coarse aggregate. The joint shall be washed to remove all loose material after cutting.

The surfaces of all construction joints shall be kept continuously moist for at least 1 hour prior to placement of the new concrete. The new concrete shall be placed directly on the cleaned and washed surface. New concrete shall not be placed until the hardened concrete has cured at least 12 hours.

Concrete shall not be dropped more than 5 feet vertically unless suitable equipment is used to prevent segregation. Concrete containing superplasticizer shall not be dropped more than 12 feet vertically.

Immediately after the concrete is placed in the forms, it shall be consolidated by vibration, spading or hand tamping as necessary to insure smooth surfaces and dense concrete. Care should be taken not to over-vibrate concrete containing superplasticizer. Vibration shall not be supplied directly to the reinforcing steel, the forms or concrete which has hardened to the degree that it does not insure a monolithic bond with the preceding layer. The use of vibrators to transport concrete in the forms or conveying equipment will not be permitted.

9. FORM REMOVAL AND FINISHING

Forms shall be left in place for at least 24 hours after placing concrete. Forms shall be removed in such a way as to prevent damage to the concrete. Supports shall be removed in a manner that will permit concrete to take the stresses due to its own weight uniformly and gradually.

Immediately after removal of the forms, concrete which is honey combed, damaged or otherwise defective shall be repaired or replaced. All cavities or depressions resulting from form tie removal shall be patched with a non-shrink grout, mortar mix or epoxy-type sealer. Non-shrink grout consists of 1 part cement and 2-1/2 parts sand that will pass a No. 16 sieve. Only enough water shall be added to produce a filling which is at the point of becoming rubbery when the material is solidly packed.

All repaired and patched areas shall be cured as required in Section 10.

10. CURING

Concrete shall be cured for a period of not less than 7 consecutive days by one of the following approved methods:

1. Membrane Curing: Concrete shall be cured with white pigmented curing compound. The compound shall be sprayed on moist concrete as soon as free water has disappeared, but shall not be applied to any surface until patching, repairs and finishing of that surface are completed. Curing compound shall not be applied to surfaces requiring bond to subsequently placed concrete, such as construction joints, shear plates, reinforcing steel, and other embedded items. Surfaces subjected to heavy rainfall or running water within 3 hours after curing compound has been applied or surfaces damaged by subsequent construction operations during the curing period, shall be reapplied in the same manner as the original application.
2. Moist Curing: Concrete shall be cured by maintaining all surfaces continuously wet for the entire curing period.
3. Cover: Adequately cover an exposed structure with burlap mats, or other material and continually soak with water.

11. BACKFILLING

Backfilling may begin when the curing period has ended. Backfill against the structure will be placed in no more than 4-inch layers and compacted by hand tamping or with manually directed power tampers or plate vibrators. Layers compacted in this manner shall extend not less than 2 feet from any part of the concrete structure.

12. HOT AND COLD WEATHER CONCRETING

When the atmospheric temperature may be expected to drop below 40° F. at the time concrete is delivered to the work site, during placement, or at any time during curing period, concrete shall be mixed, placed and protected in accordance with ACI Standard 306, "Recommended Practice for Cold Weather Concreting."

When climatic or other conditions are such that the temperature of the concrete may reasonably be expected to exceed 90o F. at the time of delivery to the work site, during placement or during the first 24 hours after placement, concrete shall be mixed, placed and protected in accordance with ACI Standard 305, "Recommended Practice for Hot Weather Concreting."

13. SPECIFIC SITE REQUIREMENTS

- A. Measurement and Payment

Compensation for any work item described in the contract documents but not listed in the bid schedule will be included in the payment for the item of work to which it is made subsidiary. Such items and bid items to which they are made subsidiary are identified in Items of Work and Construction Details section of this specification.

For items of work which lump sum prices are established in the contract, the quantity of work will not be measured for payment. Payment for each item will be made at the contract lump sum price and will constitute full compensation for completion of the work.

For items of work for which specific unit prices are established in the contract, the payment will be made based on the approved quantity measured by the engineer or weight tickets. Payment will constitute full compensation of the work completed as defined by each work item.

B. Items of Work and Construction Details

1. Subsidiary Item - Concrete

This item shall consist of all necessary concrete, reinforcing steel, formwork, materials, and labor to place poured concrete and reinforced concrete as shown in the drawings including, but not limited to, the Water Control Structure and concrete collars around pipe connections.

No separate payment will be made for Concrete. Compensation for this item will be included in the payment for the Water Control Structure and Tile Installation.

However, concrete structures that meet the Iowa Statewide Urban Design and Specifications (SUDAS), will be paid as discussed below.

2. Bid Item No. 9 – Reinforced Concrete Pipe

The work shall consist of constructing the necessary reinforced concrete pipe that meets SUDAS Division 4, Section 4020 as noted in the drawings. Materials, installation, bedding, measurement, and payment shall be in accordance with the requirements of SUDAS 4020.

3. Bid Item No. 13 – Modified SW-513 Inlet Structure

The work shall consist of constructing and installing the modified SW-513 (Open-sided Area Intake) structure that meets the requirements of SUDAS Division 6, Section 6010 and as noted in the drawings. Shop drawings shall be provided to and approved by the engineer prior to ordering structures.

Measurement and payment shall be on a per-unit basis and shall include the items required in SUDAS and the weir, grate, steel angles, hardware, all necessary fittings and adapters, concrete collar, excavation, earthfill, erosion controls, and all necessary work and appurtenances to construct the special structures shown in the drawings.

4. Bid Item No. 14 – Modified SW-513 Outlet Structure

The work shall consist of constructing and installing the modified SW-513 (Open-sided Area Intake) structure that meets the requirements of SUDAS Division 6, Section 6010 and as noted in the drawings. Shop drawings shall be provided to and approved by the engineer prior to ordering structures.

Measurement and payment shall be on a per-unit basis and shall include the items required in SUDAS and the weir, grate, steel angles, AgriDrain (or approved equal) water control

structure, bedding rock, 12" dual-wall pipe, 12" elbow, Hickenbottom (or approved equal) intake, trash guard with appurtenances, hardware, all necessary fittings and adapters, concrete collar, excavation, earthfill, erosion controls, and all necessary work and appurtenances to construct the special structures shown in the drawings.

5. Bid Item No. 15 – SW-401 Concrete Manhole Structure

The work shall consist of constructing and installing the SW-401 storm manhole structure that meets the requirements of SUDAS Division 6, Section 6010 and as noted in the drawings. Shop drawings shall be provided to and approved by the engineer prior to ordering structures.

Measurement and payment shall be on a per-unit basis and shall include all necessary fittings and adapters, excavation, earthfill, sub-base preparation, removal of water, concrete collar at joint, erosion control, all appurtenances and all necessary work to construct the special structures shown in the drawings. Payment will also include connections to existing pipes and 8 feet of pipe per connection to connect existing clay tiles. Pipe for connections shall be of an inside diameter equal to or greater than the existing clay tile. If conditions require additional length of pipe, contractor shall get approval from engineer and the quantity will be paid under the appropriate bid item.

6. Bid Item No. 16 – Reinforced Concrete Apron, Footing, Bar Guard

The work shall consist of constructing the necessary Concrete Apron, RCP Apron Section Footing, and Concrete Pipe Apron Guard that meet SUDAS Division 4, Section 4030 as noted in the drawings.

In general, the Concrete Apron shall meet the requirements of SUDAS 4030, unless otherwise stated in the drawings. The excavation for and subsequent installation of the apron shall be as shown in the drawings.

Measurement and payment shall be on a per-unit basis and shall include: all necessary fittings and adapters; excavation; earthfill; sub-base preparation; removal of water; concrete collar at joint; erosion controls; footing; bar guard; and all necessary work and appurtenances to construct the apron shown in the drawings.

7. Bid Item No. 17 – Tied Concrete Block Mat

This item shall consist of furnishing and placing Tied Concrete Block Mat (TCBM) on the connection channel as shown in the plans. TCBM shall be Flexamat Plus or an approved equal TCBM with triple layered underlayment on the spillway. Installation shall be per the details on the following page and as shown in the plans. Measurement and payment shall be plan quantity and shall include all anchors and embedded length. Installation shall occur with the engineer present.

EMERGENCY SPILLWAY - ISOMETRIC VIEW

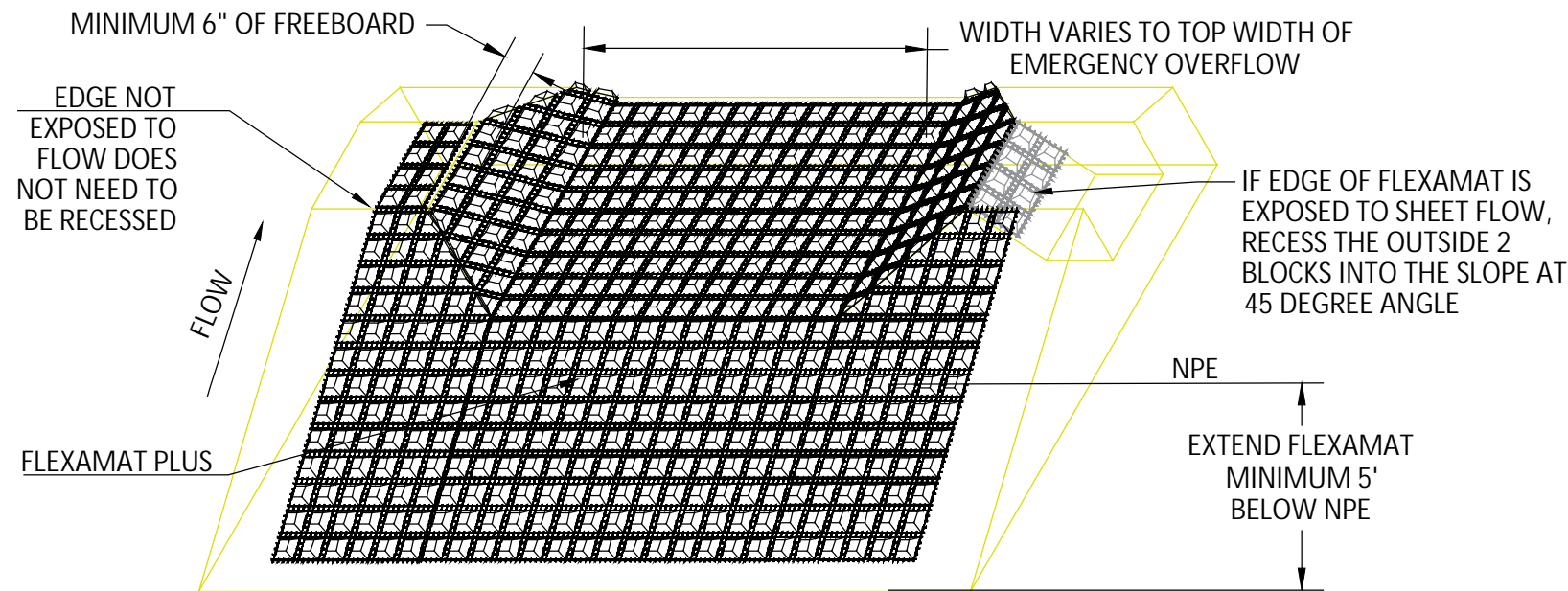

OVERFLOW DIKE - PROFILE VIEW

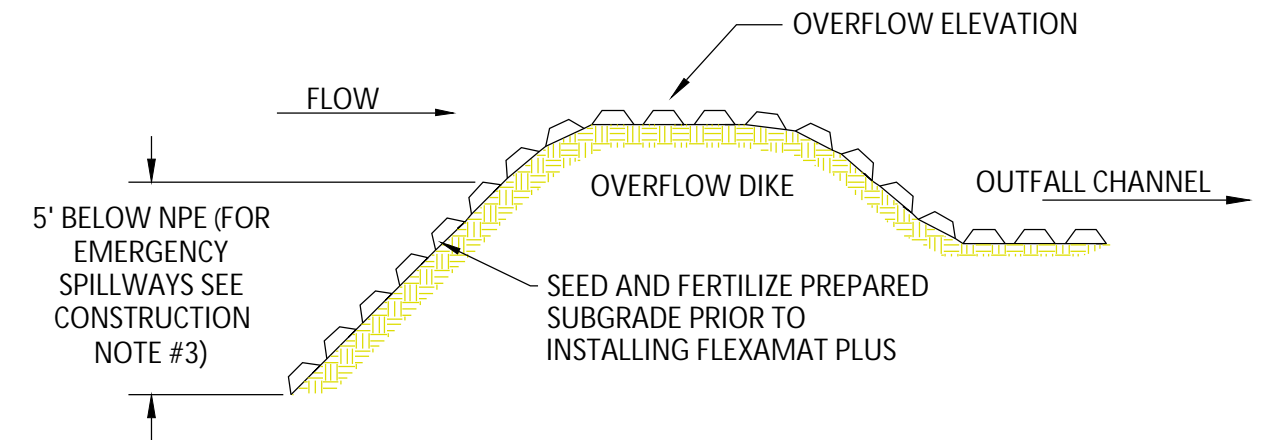

1. OVERLAP METHOD FOR SEAMS PERPENDICULAR TO FLOW

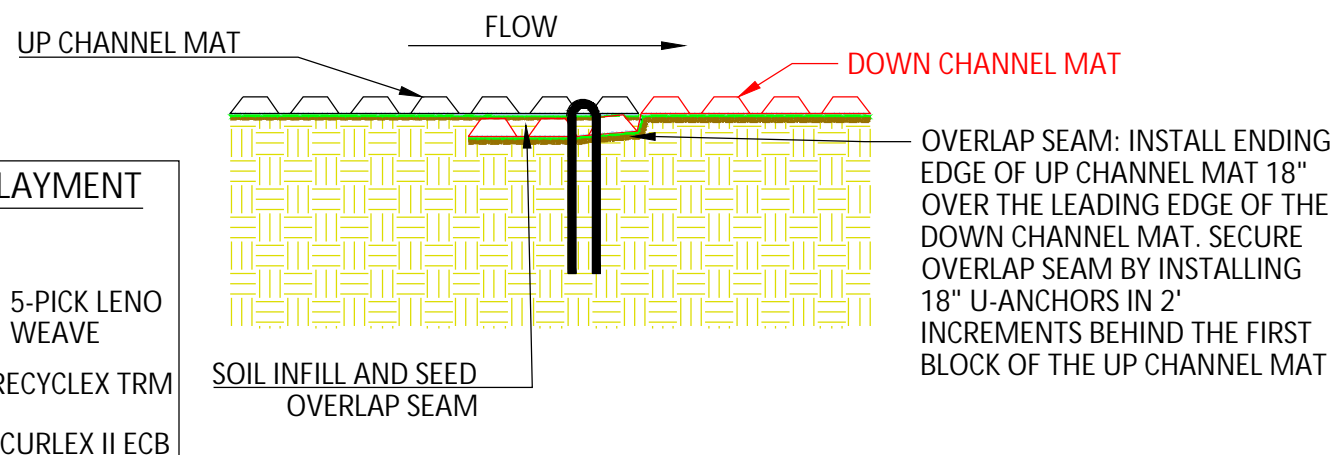

2. OVERLAP METHOD FOR SEAMS PARALLEL TO FLOW

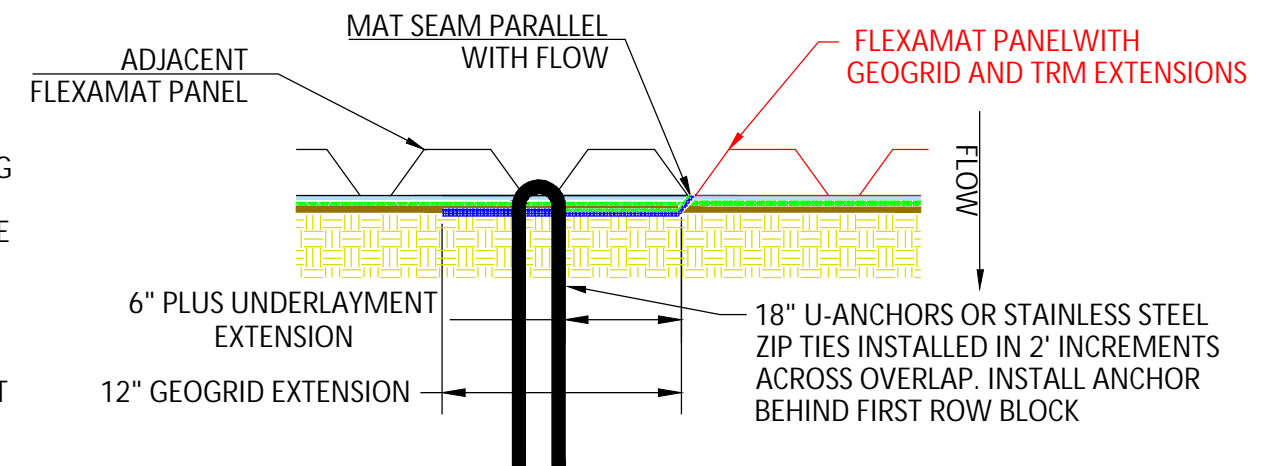

FLEXAMAT PLUS - OVERFLOW CHANNEL PARALLEL TO FLOW

CONSTRUCTION NOTES:

1. AN ENGINEER OR MANUFACTURERS REPRESENTATIVE SHALL BE ONSITE FOR THE START OF THE INSTALLATION.
2. ALL SUBGRADE SURFACES PREPARED FOR PLACEMENT OF MATS SHALL BE SMOOTH AND FREE OF ALL ROCKS, STICKS, ROOTS, OTHER PROTRUSIONS, OR DEBRIS OF ANY KIND. THE PREPARED SURFACE SHALL PROVIDE A FIRM UNYIELDING SUBGRADE FOR THE MATS.
3. PRIOR TO THE FLEXAMAT PLUS INSTALLATION SEED AND FERTILIZE SUBGRADE WITH SITE SPECIFIC SEED MIX IN ACCORDANCE WITH THE PROJECT PLANS AND SPECIFICATIONS.
4. MAT SHALL EXTEND 5' BELOW NORMAL POND ELEVATION. (FOR EMERGENCY OVERFLOW INSTALLATIONS EXTEND THE MAT 3' DOWN THE INSIDE FACE OF THE OVERFLOW DIKE.)
5. INSTALL FLEXAMAT PLUS ROLLS. MANUFACTURER RECOMMENDS INSTALLING THE WIDEST MAT POSSIBLE FOR SPILLWAY APPLICATIONS.
 - 5.1. FOR WIDTHS WIDER THAN 16', INSTALL 15.5' WIDE MATS WITH GEOGRID AND TRM UNDERLAYMENT EXTENSIONS. INSTALL ADJACENT MAT OVER THE 12" GEOGRID AND 6" TRM UNDERLAYMENT EXTENSIONS OF THE ADJACENT MATS. ENSURE THE GEOGRID AND TRM UNDERLAYMENT EXTENSIONS ARE LAYING FLAT ON THE SUBGRADE BEFORE INSTALLING ADJACENT MAT OVER THE EXTENSIONS. INSTALL #3 REBAR 18" U-ANCHORS IN 2' INCREMENTS ACROSS THE GEOGRID AND TRM EXTENSION OVERLAP. INSTALL ANCHORS PERPENDICULAR TO THE FLOW DIRECTLY BEHIND FIRST ROW OF BLOCKS ON THE ADJACENT MAT.
 - 5.2. FOR ADDITIONAL SECTIONS OF MAT, OVERLAP THE DOWNSTREAM SECTION 18" WITH UPSTREAM SECTION OF MAT. PRIOR TO INSTALLING OVERLAP, FLIP UPSTREAM MAT BACK 24". EXCAVATE 2.25" OF SOIL 18" FROM THE END OF THE UPSTREAM MAT. DOWNSTREAM SECTION IS THEN LAID IN THE SHALLOW TRENCH. RETURN AND TAMP SOIL OVER INITIAL EDGE AND SEED AREA. FLIP END OF UPSTREAM MAT OVER THE SOIL COVERED INITIAL LEADING EDGE. SEED AND FERTILIZE SOIL INFILL PRIOR TO FLIPPING END OF UPSTREAM MAT OVER THE SOIL COVERED INITIAL LEADING EDGE OF DOWNSTREAM MAT. SECURE PERPENDICULAR OVERLAP SEAMS BY INSTALLING #3 REBAR - 18" U ANCHORS PERPENDICULAR TO FLOW IN 2' INCREMENTS.
6. AT THE END OF THE ARMORED SPILLWAY, EMBED THE MAT 18" IN A TERMINATION TRENCH. FILL AND COMPACT TERMINATION TRENCH WITH SUITABLE FILL. (AS SPECIFIED BY EOR.)

MOTZ ENTERPRISES, INC.

Flexamat

(513)772-6689

Info@Flexamat.com

Flexamat.com



**NATURAL RESOURCES CONSERVATION SERVICE
CONSTRUCTION SPECIFICATION**

IA-46 TILE DRAINS FOR LAND DRAINAGE

1. SCOPE

The work shall consist of furnishing and installing drainage tubing and tile and the necessary fittings and appurtenances.

2. MATERIALS

Concrete drain tile shall conform to the requirements of ASTM C 412 and clay drain tile shall conform to the requirements of ASTM C 4.

Corrugated polyethylene (PE) pipe (tubing) and fittings shall conform to ASTM F 405 (3" to 6") or F 667 (3" to 24"), as appropriate. Corrugated profile wall (dual wall) polyethylene (PE) pipe shall meet or exceed the requirements of ASTM F 2648 (2" to 60") or ASTM F 2306 (12" to 60"). Pipe conforming to AASHTO M 252 (3" to 10") or AASHTO M 294 (12" to 60") is acceptable. Perforated tubing shall have a water inlet area of at least 1 square inch per foot, provided by perforations spaced uniformly along the long axis of the tubing. The perforations shall be circular or slots. Circular perforations shall not exceed 3/16 inch in diameter. Slots shall not be more than 1/8 inch wide.

3. EXCAVATION

Unless otherwise specified, excavation for and subsequent installation of each drain line shall begin at the outlet end and progress upstream.

The trench or excavation for the tile shall be constructed to the line, depths, cross sections, and grade shown on the drawings or as directed by the NRCS Inspector. The trench bottom shall be smooth and free of exposed rock. If rock is encountered in the trench bottom, over-excavate the trench and place at least 6 inches of compacted earth or sand bedding in the trench to bring it up to the conduit grade.

If not otherwise shown on the drawings, trench width at the top of the conduit shall be the minimum required to permit installation and provide bedding conditions suitable to support the load on the conduit, but with not less than three (3) inches of clearance on each side of the conduit. Maximum trench width shall be the conduit diameter plus 12 inches measured at the top of the conduit, unless approved bedding is installed.

Trench shields, shoring and bracing, or other methods, necessary to safeguard the workers and work, and to prevent damage to the existing improvements shall be furnished, placed, and subsequently removed by the contractor.

Plow installation is allowed. Minimum trench width shall be two (2) inches wider than the conduit on each side. Grade control and bedding conditions shall be closely inspected during plow installation. Boulders, cobbles, or cemented soil can cause the plow to jump or lose grade. These hardpoints can also puncture or dimple and deform the pipe.

4. PREPARING THE BEDDING

Unless otherwise specified, no filter or envelope is required. In stable soils the bottom of the trench shall be shaped to form a semicircular, trapezoidal, or 90 degree "V" groove in its center. The groove shall be shaped to fit the size of tile. The 90-degree "V" groove shall not be used on conduits greater than 6 inches in diameter.

If the bottom of the trench does not provide a sufficiently stable or firm foundation for the drain tile, a sand-gravel mix or other approved materials shall be used to stabilize the bottom of the trench.

5. FILTER OR ENVELOPE MATERIAL

When a filter is specified, the shape of the bottom of the trench, gradation and the thickness of the filter or envelope material to be placed around the tile will be as shown on the drawings. The envelope or filter material shall be placed in the bottom of the trench just prior to the laying of the tile. The tile shall then be laid and the envelope or filter material placed over the tile.

6. PLACEMENT AND JOINT CONNECTIONS

All drains shall be laid to grade.

Joints between lateral drain tile shall vary with soil type as follows:

- a. Peat and muck - 1/4 inch preferred, 3/8 inch maximum
- b. Clay - 1/8 inch preferred, 1/4 inch maximum
- c. Silt and loam - 1/16 inch preferred, 1/8 inch maximum
- d. Sand - tightest possible fit.

Joint between main drain tile which serve only to collect and transport drainage water from lateral tile lines should be the tightest fit possible.

Where the joint width exceeds the maximum above, the joint shall be covered with a permanent type material such as coal tar pitch treated roofing paper, fiber glass sheet or mat, or plastic sheet.

After placement and blinding of plastic tubing, but prior to backfilling, sufficient time shall elapse to allow the tubing to reach the ambient temperature of the trench. All split fittings shall be securely tied with nylon cord before backfill is placed. When corrugated plastic tubing is used, no more than 5% stretch will be allowed.

7. CONNECTIONS

Lateral connections will be made with manufactured appurtenances (wyes, tees, etc.) comparable in strength and durability with the specified tile or tubing unless otherwise shown on the drawings.

Existing tile lines not shown on the drawings but encountered during installation shall be bridged across the trench or connected into the new line, as directed by NRCS.

Connections with the outlet pipe shall be made watertight.

8. OUTLETS

A continuous section of non-perforated conduit at least 20 feet long shall be used at the outlet. At least two-thirds of the outlet pipe shall be buried in the ditch bank, and the cantilever section must extend to the toe of the ditch side slope or the side slope protected from erosion. Acceptable materials for use at the outlet include the following:

- a. Corrugated metal pipe, galvanized or aluminum, 16 gauge minimum;
- b. Smooth steel pipe with a minimum wall thickness of 3/16 inch;
- c. Smooth plastic pipe, polyvinyl chloride (PVC), with a SDR of 26 or less or schedule 40 or heavier; or
- d. Corrugated profile wall (dual wall) polyethylene pipe (PE).

All plastic (PVC) and polyethylene pipe (PE) outlets shall include ultra-violet stabilizer. PVC or PE pipe outlets shall not be used where burning vegetation on the outlet ditch bank is likely to create a fire hazard.

The outlet shall be equipped with a flap-gate type rodent guard.

9. BLINDING

After the tubing or tile is placed in the excavated groove, friable material from the sides of the trench shall be placed around the tubing, completely filling the trench to a depth of not less than three inches over the top of the tubing. For material to be suitable it must not contain hard clods, rocks, frozen soil, or fine material which will cause a silting hazard to the drain. Tubing placed during any one day shall be blinded by the end of the day's work.

10. BACKFILLING

The backfilling of the trench shall be completed as rapidly as consistent with the soil conditions. Automatic backfilling machines may be used. Backfill shall extend above the ground surface and be well rounded over the trench.

Unless otherwise shown on the plans, in mineral soils, the minimum cover over subsurface drains shall be 2.4 feet. In organic soils, the minimum depth of cover after initial subsidence shall be 3.0 feet.

11. SPECIAL SPECIFICATIONS

A. Measurement and Payment

Compensation for any work item described in the contract documents but not listed in the bid schedule will be included in the payment for the item of work to which it is made subsidiary. Such items and bid items to which they are made subsidiary are identified in Items of Work and Construction Details section of this specification.

For items of work which lump sum prices are established in the contract, the quantity of work will not be measured for payment. Payment for each item will be made at the contract lump sum price and will constitute full compensation for completion of the work.

For items of work for which specific unit prices are established in the contract, the payment will be made based on the approved quantity measured by the engineer or weight tickets. Payment will constitute full compensation of the work completed as defined by each work item.

B. Items of Work and Construction Details

1. Bid Item No. 10 – Smooth Lined CPDT Pipe (15" Diameter)

This item will consist of furnishing and installing the Dual-wall corrugated pipe as shown on the plans. Pipe shall be Fratco FLEXCORR or approved equal. Pipe may be installed with an open trench or a tile plow. Installation shall be per Sheet B.01.

Measurement and payment for the corrugated profile wall (Dual wall) Polyethylene pipe shall be on an installed linear foot basis, and shall include all necessary fittings and adapters.

Payment will also include all subsidiary items required for installation such as trench excavations, backfill, site preparation, and removal of water, and concrete collar at joint. Additional fill required to provide adequate cover as needed is included in Earthfill, General.

2. Bid Item No. 11 – Tile Connection – 10” Dia. Or Smaller

This item will consist of making the major tile connections as marked in the plans as well as any unforeseen connections that may be encountered in the field. All field tiles encountered are to be reconnected to the new tiles unless otherwise specified in the plans. Connections to manholes are not included in this bid item but are subsidiary to the manhole bid items.

Payment will include all subsidiary items required for connection such as additional pipe, manufactured appurtenances, excavations, backfill, site preparation, removal of water, and concrete collars at joints.

3. Bid Item No. 12 – Tile Connection – 12” Dia. Or Larger

This item will consist of making the major tile connections as marked in the plans as well as any unforeseen connections that may be encountered in the field. All field tiles encountered are to be reconnected to the new tiles unless otherwise specified in the plans. Connections to manholes are not included in this bid item but are subsidiary to the manhole bid items.

Payment will include all subsidiary items required for connection such as additional pipe, manufactured appurtenances, excavations, backfill, site preparation, removal of water, and concrete collars at joints.

Construction Specification 000 IA-61 Loose Rock Riprap

1. SCOPE

The work shall consist of the construction of loose rock riprap revetments, structures and blankets, including filter layers or bedding where specified.

2. MATERIALS

Rock for loose rock riprap, filter layers or bedding shall come from sources approved by NRCS. The rock shall be excavated, selected and handled as necessary to meet the quality and grading requirements of this specification and the construction drawings.

Individual rock fragments shall be dense, sound and free from cracks, seams and other defects conducive to accelerated weathering. The rock fragments shall be angular to sub rounded in shape. The least dimension of an individual rock fragment shall not be less than 1/3 the greatest dimension of the fragment unless otherwise specified on the construction drawings.

3. SUBGRADE PREPARATION

The subgrade surfaces on which the riprap or bedding is to be placed shall be cut or filled and graded to the lines and grades shown on the drawings. When fill to subgrade lines is required, it shall consist of approved materials and shall be compacted to a density equal to the adjacent existing soil material.

Rock materials shall not be placed until the foundation preparation is completed and the subgrade surfaces have been inspected and approved by NRCS.

4. EQUIPMENT-PLACED ROCK RIPRAP

Rock shall be placed by equipment on the surfaces and to the depths specified. The riprap shall be constructed to the full thickness in one operation and in such a manner as to avoid serious displacement of the underlying materials. The rock shall be delivered and placed in a manner that will ensure that the riprap in place shall be reasonably homogeneous with the larger rocks uniformly distributed and firmly in contact, one to another, with the smaller rocks and spalls filling the voids between the larger rocks. Placement of rock shall begin at the bottom of the slope or downstream end of the structure.

Riprap shall be placed in a manner to prevent damage to structures. Hand placing will be required to the extent necessary to prevent damage to adjacent structures.

5. HAND-PLACED RIPRAP

Rock shall be placed by hand on the surfaces and to the depths specified. It shall be securely bedded with the larger rocks firmly in contact, one to another. Spaces between the larger rocks shall be filled with smaller rocks and spalls. Smaller rocks shall not be grouped as a substitute for larger rock. Flat slab rock shall be laid on edge unless otherwise specified. Placement of rock shall begin at the bottom of the slope or downstream end of the structure.

6. FILTER LAYERS OR BEDDING

When the drawings specify filter layers or bedding beneath riprap, the filter or bedding material shall be spread uniformly on the prepared subgrade surfaces to the depth specified. Compaction of filter layers or

bedding will not be required, but the surface of such layers shall be finished reasonably free of mounds, dips or windrows.

7. SPECIFIC SITE REQUIREMENTS

A. Measurement and Payment

Compensation for any work item described in the contract documents but not listed in the bid schedule will be included in the payment for the item of work to which it is made subsidiary. Such items and bid items to which they are made subsidiary are identified in Items of Work and Construction Details section of this specification.

For items of work which lump sum prices are established in the contract, the quantity of work will not be measured for payment. Payment for each item will be made at the contract lump sum price and will constitute full compensation for completion of the work.

For items of work for which specific unit prices are established in the contract, the payment will be made based on the approved quantity measured by the engineer or weight tickets. Payment will constitute full compensation of the work completed as defined by each work item.

B. Items of Work and Construction Details

1. Bid Item No. 18 – Rip Rap (Class E)

This item shall consist of furnishing and placing the rock riprap in the locations as shown on the drawings. Rock shall be Class E Revetment Stone as defined by Iowa Department of Transportation (DOT).

All rip rap shall comply with Iowa DOT Section 4130.

Payment will be based on actual tonnage delivered to the site based on weight tickets to the nearest 0.1 ton, subject to the approval of the engineer.

Payment will constitute full compensation for the following related subsidiary items: Pollution Control, Removal of Water, Structure Excavation and Geotextile Fabric.

2. Subsidiary Item – Geotextile Fabric

Geotextile Fabric, IA-95