NAVIYD

Product Specifications	332
Product Planning Information	333
Product Options	335
Factory Installed Grommet and Cutout Options	336
Product Pages	338

PRODUCT SPECIFICATIONS

DETAILS

- Configured desk models include the base, worksurface and ships ready to assemble
- Component bases include the base frame and ships ready to assemble.
IMPORTANT: Worksurfaces must be specified separately
- Models with base top ship in two cartons; assembly is required
- Four table base styles:
 - T-leg
 - T-leg L-configuration
 - C-leg
 - Single-column H

WORKSURFACE

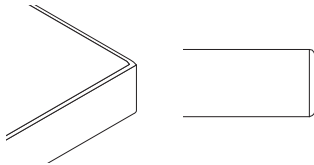

- Table desk worksurface sizes range from a nominal 36" to 72"
- Worksurfaces are available in HPL (high pressure laminate) 1 $\frac{3}{8}$ " T or TFL (thermally fused laminate) 1 $\frac{1}{2}$ " T, and both feature a 3mm PVC rim
- Grain direction runs left-to-right unless otherwise noted
- Factory installed grommets and cut-outs are available in predetermined locations; upcharge applies. See pages 336-337

TABLE BASES

- Bases are formed metal with a powder coat finish available in 3 standard finishes, Designer White, Cinder, Platinum Silver
- Optional powder finishes are available at an upcharge
- Bases are standard with 2" diameter black plastic glides with a $\frac{1}{2}$ " adjustment for unlevel floors
- Casters – Field installed caster kit (set of 4) available; order separately:
 - used only on T-legs base style with rectangular worksurface tops 23"-29"
 - not available on C-base styles
 - low profile black plastic – add 1 $\frac{1}{2}$ " to overall heights
 - weight load for desk is 130 pounds with casters

HEIGHT ADJUSTABLE TABLE DESK

- Control pad can be moved to right-handed (RH) or left-handed (LH) by the customer
- Height adjustable range (with worksurface):
 - standard height mechanism is 26" to 42 $\frac{1}{4}$ "
 - extended height mechanism is 22 $\frac{1}{2}$ " to 48 $\frac{1}{2}$ "
- Lifting Capacity of base without worksurface:
 - table desks are 265 pounds
 - single column H is 132 pounds
- Adjustment speed is 1.3" per second
- Standard with Up and Down controller
- Two Optional Controller are available; see page 358
- Table desk frame width is expandable in 6" increments
- Standard features:
 - anti-collision
 - overheat protection
 - overload protection

CORD MANAGEMENT

- Round grommets, racetrack grommets and wire managers are optional on worksurfaces
- Wire managers are available for vertical cable managers, cable carriers and maple cable basket; see page 773
- Refer to page 773 for available grommet/wire manager colors
- Refer to pages 336-337 for complete grommet locations and details

MONITOR ARMS

Clamp mount monitor arms cannot be used with modesty panel. It is recommended to field install a grommet mount model in a location to clear the modesty.

CONTROL BOX MECHANISM INFORMATION

- Motor per style:
 - straight line table desk has 1 control box, 2 motors
 - single column H has 1 control box, 1 motor
 - L-configurations desk has 1 control box, 3 motors
- Anti-collision function on control box will engage when a firm obstruction is detected and will stop worksurface travel
- Overheat protection will stop the unit should the motor overheat due to being heavily loaded or if driven continuously. Operation of the desk can resume in approximately 15 minutes
- Overload protection detects if the load is too heavy and will stop the unit. Remove the load and resume use
- Control box includes a 9' power cord with two-prong plug

IMPORTANT: The customer bears the responsibility to verify that the installation of Navyid height adjustable desks complies with all local municipal electrical codes. Some municipalities require the worksurface and base to be sold as an assembly that is listed to UL 962. In these justifications, specify a Navyid configured desk (base sold with a worksurface) model. Navyid height adjustable bases (sold separately) will not bear the ETL mark. Base only models are available for use with specific Navyid worksurfaces (sold separately) which align cut-outs, grommets, and screen brackets with the base understructure.

Navyid height adjustable, base only models can accept other Kimball and National brand worksurfaces in $\frac{3}{4}$ ", $\frac{1}{2}$ ", and $\frac{1}{8}$ " thickness. It is the customer's responsibility to maintain recommended safety clearances to minimize pinch/crush hazards when using other Kimball and National brand worksurfaces.

Field installed grommets and cutouts are recommended where standard locations may interfere with the base understructure. Worksurface size should not exceed the recommended size.

Use of non-Kimball and non-National brand worksurfaces are not recommended and is the sole responsibility of the customer and may void the product warranty.

DIMENSION KEY	
D	Depth
W	Width
H	Height
A	Overhang: Approach Side
KW	Kneespace Width

PRODUCT PLANNING INFORMATION

WORKSURFACE CLEARANCE

1" minimum clearance around the sides and back is required when placing height adjustable worksurfaces next to each other to minimize pinch/crush hazards. A clearance of less than $\frac{3}{16}$ " is acceptable next to a fixed wall or panel where the clearance is maintained through the travel range. Base feet are $2\frac{3}{8}$ " deep.

STATIONARY STORAGE PLANNING

Pedestals, overhead storage, or components should not be installed in the path of the height adjustable desks. Underside of desk frame to floor is $22\frac{3}{16}$ " for standard height and $18\frac{7}{8}$ " for extended height models with the leveling glide in the lowest position.

MODESTY PANELS

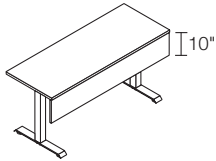

Modesty panels provide user privacy and conceal electrical components. Modesty panels can extend the full width of the worksurface or be narrower than the surface.

TFL modesty panels are $\frac{3}{4}$ " thick and are edge banded in the same material and resin modesty panels are $\frac{1}{4}$ " thick.

When using a narrower modesty panel than the worksurface width, it is recommended to use a center grommet or cut-out, because the left and right locations could sit outside the modesty depending on the width specified.

Modesty panels are not sized to fit 120° curved corner desks or the return side of height adjustable L-configurations. Specify a smaller width, such as 66" wide modesty for a 72" wide worksurface.

To avoid interference, do not place storage, and other objects beneath the desk with modesty panel.

PRIVACY SCREENS

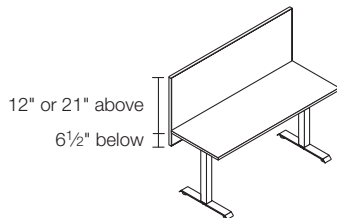

Fabric privacy screens with frame attach to height adjustable desk worksurfaces to provide space division and privacy above and below the worksurface. Privacy screens feature a tackable fabric surface (panel fabric) with an aluminum frame which is available in all paint colors. Attachment brackets are painted to match the frame. **IMPORTANT:** Privacy screens are prohibited on desks with C-leg bases as they are a tip hazard due to placement of the column being off center.

Privacy screens can be specified to span the full width, or they can be narrower than the desk worksurface. A center cut-out or grommet is recommended on the narrower application to avoid interference with the screen's mounting brackets.

Privacy screens can be mounted with a 1" maximum gap to manage cables and accommodate a clamp-mount monitor arm.

To avoid interference, do not place storage, and other objects beneath the desk with privacy screen.

CONTROLLERS

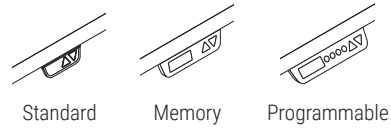

Standard up/down switch ships with all height adjustable desk bases. Switch is 2" D x $2\frac{3}{4}$ " W x $\frac{3}{4}$ " H. Allows for upper and lower limits to be set to avoid collision with storage elements.

Memory control switch with display screen can be specified separately to replace a standard switch. It operates the same as the standard up/down switch. Memory control switch allows for a low position and a high position to be set to prevent the desk from interfering with obstructions, such as pedestals and overheads.

Programmable control switch with display screen allows up to four preset/saved height settings. Specify separately to replace a standard up/down switch.

All switches can be mounted on the left or right side of the work surface and are field installed.

NAVIYD

BASE AND WORKSURFACE CONFIGURATION

- T-leg bases can be paired or are available configured with rectangular main or 120° curved corner worksurfaces
- T-leg L-configuration bases can be paired or are available configured with:
 - Rectangular main worksurface and a rectangular return (non-handed)
 - Rectangular main worksurface and a rectangular return (non-handed)
 - Extended straight (handed)
 - Extended cove (handed)
- Non-handed L-configuration models can be assembled in the field to accommodate left- or right-handed configurations
- C-leg bases can be paired or are available configured with rectangular worksurfaces only. **IMPORTANT:** C-leg bases are not available with 120° worksurface due to tipping hazard
- Single-column H component bases can be paired with 23" D x 36" W or 23" D x 42" W rectangular main worksurfaces

TOP SHAPE	TOP WIDTH	T-LEG TOP DEPTH	L-CONFIG TOP DEPTH	C-LEG TOP DEPTH	H-LEG TOP DEPTH
Rectangular Main	36" W				23"
	42" W				23"
	48" W	23"/30"		23"/30"	
	54" W	23"/30"		23"/30"	
	60" W	23"/30"	23"/30"	23"/30"	
Rectangular Return	36" W		23"		
	42" W		23"		
	48" W		23"		
120° Curved Corner	83" W	23"/30"			
Extd. Straight/Cove	71" W		23"/30"		

Note: 48" wide returns must be paired with a 23" deep main worksurface for a maximum depth of 72"; cannot be used with a 29" deep main worksurface. L bases support a maximum overall top width and depth of 72", and a minimum width and depth of 60".

DIMENSIONS

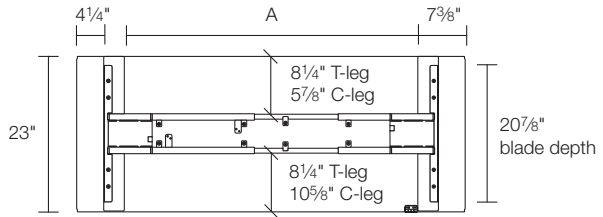
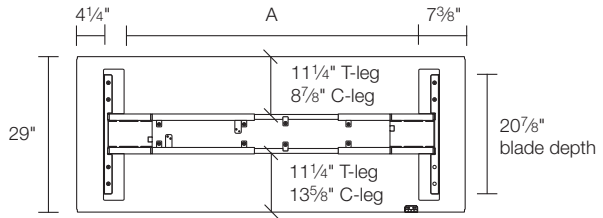

DISTANCE BETWEEN COLUMNS	
Width of Top	"A" Dimension
48"	32 3/4"
54"	38 3/8"
60"	44 3/8"
66"	50 3/8"
72"	56 3/8"

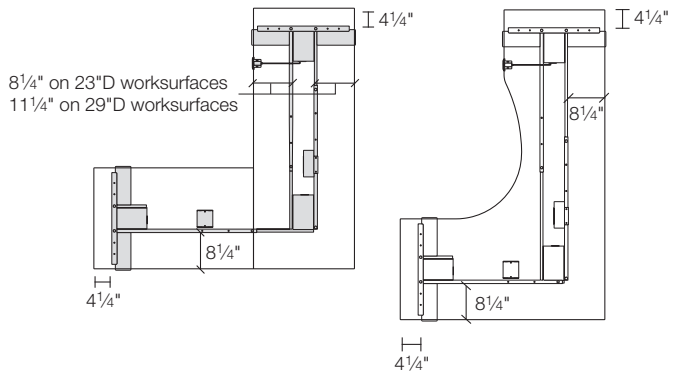
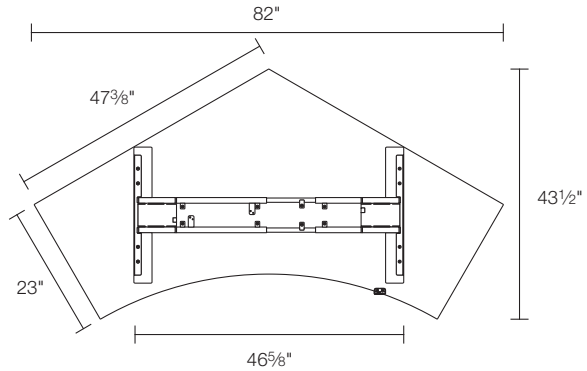

RIM PROFILE OPTIONS

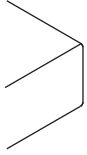

Softened PVC (V)

PVC SOFTENED RIM

AC2	Autumn 2	SM	Sonoma
AD	Almond	TF	Truffle
BZ	Brazilwood	WL	Willow
CI	Chai	405	Designer White
CL	Caramel	419	Wallaby
CW	Cordovan	425	Shadow
DW	Judicial	440	Cloud
HN2	Honey 2	457	Dapple
IM	Brighton	461	Graphite
KN	Kona	462	Cinder
MC	Amber	478	Platinum Grey
MH	Mocha	488	Frosty White
NM	Natural	491	Designer White Linear
PB	Portobello	492	Cinder Linear
PC	Porcini	792	Sable
PT	Portico	793	Acorn
SK	Skyline		

GALLERY PVC SOFTENED RIM

Grade 1 – 5% upcharge	
G1001	Citadel
G1011	Pepperdust
Grade 2 – 6% upcharge	
G1002	Planked Raw Oak
G1003	Evening Notte
G1004	Kirsche
G1005	Midnight Run
G1006	Sepia Walnut
G1007	Serotina
G1008	Timeless
G1009	White Nebbia
G1012	Phantom Ecru

See page 22 for Gallery program details and upcharges

LAMINATE WORKSURFACES AND TFL MODESTY

WOODGRAIN LAMINATE

AC2	Autumn 2
AD	Almond
BZ	Brazilwood
CI	Chai
CL	Caramel
CW	Cordovan
DW	Judicial
HN2	Honey 2
IM	Brighton
KN	Kona
MC	Amber
MH	Mocha
NM	Natural
PB	Portobello
PC	Porcini
PT	Portico*
SK	Skyline*
SM	Sonoma*
TF	Truffle
WL	Willow
792	Sable
793	Acorn**

SOLID LAMINATE

405	Designer White
419	Wallaby
425	Shadow
440	Cloud
457	Dapple
461	Graphite
462	Cinder
478	Platinum Grey
488	Frosty White
491	Designer White Linear
492	Cinder Linear

PATTERN LAMINATE

814	White Tigris
818	Crisp Linen
819	Flax Gauze
821	Elemental Concrete
822	Smoke Quarstone

- Pattern laminates not available on TFL models
- CSL available; see page 22 for program details and upcharge
- CSL not available on TFL models

GALLERY LAMINATE

Grade 1 – 5% upcharge	
G1001	Citadel
G1011	Pepperdust
Grade 2 – 6% upcharge	
G1002	Planked Raw Oak
G1003	Evening Notte
G1004	Kirsche
G1005	Midnight Run
G1006	Sepia Walnut
G1007	Serotina
G1008	Timeless
G1009	White Nebbia
G1012	Phantom Ecru

MODESTY PANEL RESIN

Grade 1	
1677	Frosted

METAL BASE PAINT COLORS

STANDARD

405	Designer White
462	Cinder
501	Platinum Metallic

PREMIUM*

105	Spinach Green
106	Cloud Blue
107	Dark Blue
111	Apricot Orange
112	Tango Red
113	Golden Rod
419	Wallaby
420	Sandstone
425	Shadow
440	Cloud
450	Fog
460	Storm
461	Graphite
488	Frosty White
504	Silver Pearl

*10% List Upcharge

PRIVACY SCREEN FABRIC OPTIONS

Dune (Grade A) 100% Polyester	Repetition (Grade A) 100% Pre-Consumer Recycled Polyester	COM (Grade B)	Pact (Grade B) 65% Pre-Consumer Recycled Polyester, 35% Post-Consumer Recycled Polyester
8600 Drift	3700 Ash		25401 Aloe
8601 Windblown	3703 White		25402 Azure
8602 Erosion	3709 Java		25403 Calla
8603 Haze	3713 Stainless		25404 Coastal
8606 Pebble	3715 Almond		25405 Delft
8608 Nectar	3721 Reed		25406 Dove
8610 Clear Sky	3744 Tawny		25409 Fern
8614 Basin			25410 Harbour
8615 Raven			25411 Lily
8620 Darkness			25412 Lime
			25413 Midnight
			25414 Nectar
			25415 Patina
			25416 Putty
			25418 Roma
			25420 Sketch
			25422 Taupe
			25423 Toasty

NAVIYD - FACTORY INSTALLED GROMMET OPTIONS

FACTORY INSTALLED GROMMET OPTIONS

If no grommet is desired, specify an X (No Grommet)

Round Grommet, Black Plastic

\$30 list for each grommet

- G1L Left
- G1R Right
- G1LR Left & Right
- G1C Center
- G1LC Left & Center
- G1RC Right & Center
- G1A Left, Right & Center

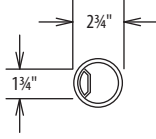

Racetrack Grommet, Satin Nickel Metallic

\$35 list for each grommet

- G11SNL Left
- G11SNR Right
- G11SNLR Left & Right
- G11SNC Center
- G11SNLC Left & Center
- G11SNRC Right & Center
- G11SNA Left, Right & Center

Racetrack Grommet, Platinum Metallic

\$35 list for each grommet

- G11PLL Left
- G11PLR Right
- G11PLLRL Left & Right
- G11PLC Center
- G11PLLCL Left & Center
- G11PLRC Right & Center
- G11PLA Left, Right & Center

Racetrack Grommet, Cinder

\$35 list for each grommet

- G11MBL Left
- G11MBR Right
- G11MBLR Left & Right
- G11MBC Center
- G11MBLC Left & Center
- G11MBRC Right & Center
- G11MBA Left, Right & Center

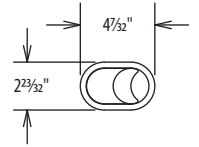

IMPORTANT: Grommets are not available for worksurfaces on single column H-base.

CUT OUT	DESIGNATOR	UPCHARGE
G12	CUT-G12C	\$30
G17	CUT-G17C	\$30
G33	CUT-G33C	\$30

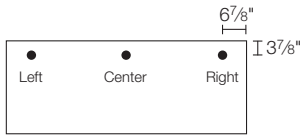

Rectangular

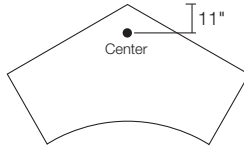

Curved Corner

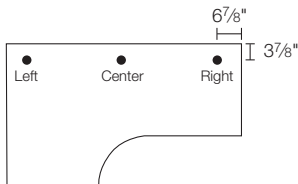

Extended Straight

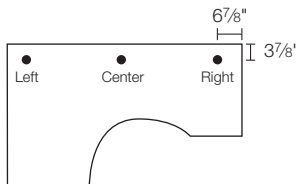

Extended Cove

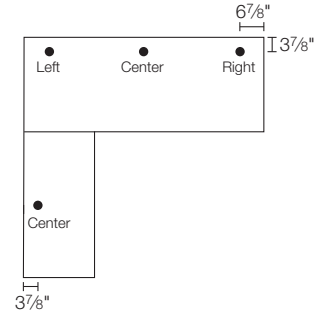

L Worksurface Main and Return

Note: All dimensions for grommets are measured from the center of the grommet to the worksurface edge. Grommets are specified separately for the main and return worksurfaces on L models

FACTORY INSTALLED CUTOUT

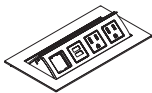

G12
3 configurations available
available in Black, Silver, & White
sold separately in Accessories Section



G17
3 configuration available
available in Black, Silver, & White
sold separately in Accessories Section

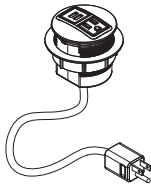

G33
available in Black, Silver, & White
sold separately in Accessories Section

CUTOUT LOCATIONS

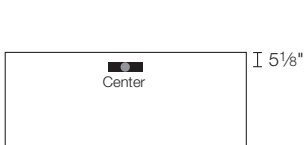

Rectangular

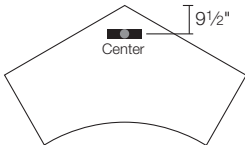

Curved Corner

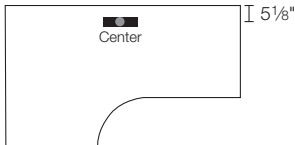

Extended Straight

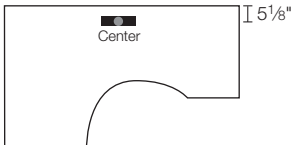

Extended Cove

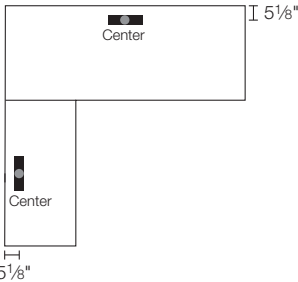

L Worksurface Main and Return

NAVIYD

PRODUCT SPECIFICATIONS

- Base includes control box, 9' power cord, and standard up/down control switch
- Worksurfaces must be specified separately; see page 332
- Base ships ready to assemble

TO ORDER, SPECIFY:

1. Model Number
2. Paint

SAMPLE MODEL NUMBER:

- 65N41ABSTP 501
- See pages 335-337 for all options available in Naviyd

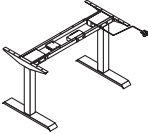
	MODEL NO./DESCRIPTION	LIST PRICE	DIMENSIONS				KW	CARTONED CUBIC	
			D	W	H	A		WEIGHT	FEET
T-LEG STANDARD HEIGHT ADJUSTABLE BASE 	65N41ABSTP Paint	\$ 1406	23%	40¾"-64¾"	24¾"-41½"	—	61 lbs.	2.7	
	<ul style="list-style-type: none"> • Maximum surface weight with caster option is 130 pounds • Caster options listed on page 358 • Standard height adjustable 24¾"-41½" • Black plastic glides are standard; 2" diameter and adjustable range ½" • Memory control and programmable switches available; see page 358 • Pedestals, overhead storage or components should not be installed in the path of the height adjustable desks • Frames are adjustable in 6" increments • Base feet are 23¾" deep 								

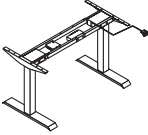
T-LEG EXTENDED HEIGHT ADJUSTABLE BASE 	65N47ABETP Paint	\$ 1695	23%	40¾"-64¾"	21¾"-47¼"	—	65 lbs.	2.7
	<ul style="list-style-type: none"> • Maximum surface weight with caster option is 130 pounds • Caster options listed on page 358 • Extended height adjustable 21¾"-47¼" • Black plastic glides are standard; 2" diameter and adjustable range ½" • Memory control and programmable switches available; see page 358 • Pedestals, overhead storage or components should not be installed in the path of the height adjustable desks • Frames are adjustable in 6" increments • Base feet are 23¾" deep 							

PRODUCT SPECIFICATIONS

- Base includes control box, 9' power cord, and standard up/down control switch
- Worksurfaces must be specified separately; see page 332
- Base ships ready to assemble

TO ORDER, SPECIFY:

1. Model Number
2. Paint

SAMPLE MODEL NUMBER:

- 65N41ABLSTP 501
- See pages 335-337 for all options available in Naviyd

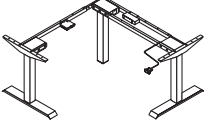
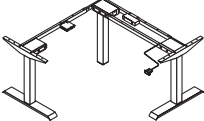
	MODEL NO./DESCRIPTION		LIST PRICE	DIMENSIONS				KW	CARTONED WEIGHT	CUBIC FEET
				D	W	H	A			
<p>T-LEG L-CONFIGURATION STANDARD HEIGHT ADJUSTABLE BASE</p> 	65N41ABLSTP	Paint	\$ 2238	47-71	52¾-64¾	24¾-41½	—	114.01 lbs.	4.17	
	<ul style="list-style-type: none"> • Standard height adjustable 24¾"-41½" • Black plastic glides are standard; 2" diameter and adjustable range ½" • Memory control and programmable switches available; see page 358 • Pedestals, overhead storage or components should not be installed in the path of the height adjustable desks • Frames are adjustable in 6" increments • Available to be paired with rectangular main and return, extended straight and cove worksurfaces • Base feet are 23¾" deep 									
<p>T-LEG L-CONFIGURATION EXTENDED HEIGHT ADJUSTABLE BASE</p> 	65N47ABLETP	Paint	\$ 2385	47-71	52¾-64¾	21¾-47¼	—	114.01 lbs.	4.17	
	<ul style="list-style-type: none"> • Extended height adjustable 21¾"-47¼" • Black plastic glides are standard; 2" diameter and adjustable range ½" • Memory control and programmable switches available; see page 358 • Pedestals, overhead storage or components should not be installed in the path of the height adjustable desks • Frames are adjustable in 6" increments • Available to be paired with rectangular main and return, extended straight and cove worksurfaces • Base feet are 23¾" deep 									

NAVIYD

PRODUCT SPECIFICATIONS

- Base includes control box, 9' power cord, and standard up/down control switch
- Rectangular worksurface only; must be specified separately; see page 332
- Base ships ready to assemble

TO ORDER, SPECIFY:

1. Model Number
2. Paint

SAMPLE MODEL NUMBER:

- 65N41ABSCP 501
- See pages 335-337 for all options available in Naviyd

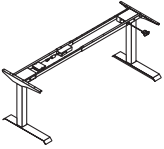
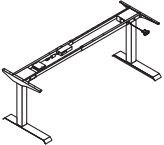
	MODEL NO./DESCRIPTION	LIST PRICE	DIMENSIONS				KW	CARTONED WEIGHT	CUBIC FEET
			D	W	H	A			
C-LEG STANDARD HEIGHT ADJUSTABLE BASE 	65N41ABSCP Paint	\$ 1546	23%	40¾"-64¾"	24¾"-41½"	—	61 lbs.	2.7	
	<ul style="list-style-type: none"> • Standard height adjustable 24¾"-41½" • Black plastic glides are standard; 2" diameter and adjustable range ½" • Memory control and programmable switches available; see page 358 • Pedestals, overhead storage or components should not be installed in the path of the height adjustable desks • Frames are adjustable in 6" increments • Screens are not to be paired with this unit due to tipping hazard 								
C-LEG EXTENDED HEIGHT ADJUSTABLE BASE 	65N47ABECP Paint	\$ 1865	23%	40¾"-64¾"	21¾"-47¼"	—	65 lbs.	2.7	
	<ul style="list-style-type: none"> • Extended height adjustable 21¾"-47¼" • Black plastic glides are standard; 2" diameter and adjustable range ½" • Memory control and programmable switches available; see page 358 • Pedestals, overhead storage or components should not be installed in the path of the height adjustable desks • Frames are adjustable in 6" increments • Screens are not to be paired with this unit due to tipping hazard 								

PRODUCT SPECIFICATIONS

- Base includes control box, 9' power cord, and standard up/down control switch
- Worksurfaces must be specified separately; see page 332
- Base ships ready to assemble

TO ORDER, SPECIFY:

1. Model Number
2. Paint

SAMPLE MODEL NUMBER:

- 65N41ABSHP 501
- See pages 335-337 for all options available in Naviyd

	MODEL NO./DESCRIPTION	LIST PRICE	DIMENSIONS					CARTONED WEIGHT	CUBIC FEET
			D	W	H	A	KW		
SINGLE-COLUMN H STANDARD HEIGHT ADJUSTABLE BASE	65N41ABSHP Paint	\$ 1214	23 $\frac{3}{8}$ "	33 $\frac{1}{2}$ "	24 $\frac{3}{4}$ "-41 $\frac{1}{8}$ "		—	50 lbs.	4.5
	<ul style="list-style-type: none"> • Standard height adjustable 24$\frac{3}{4}$"-41$\frac{1}{8}$" • Black plastic glides are standard; 2" diameter and adjustable range $\frac{1}{2}$" • Memory control and programmable switches available; see page 358 • Pedestals, overhead storage or components should not be installed in the path of the height adjustable tables • Fixed frame width • Can be paired with 23" D x 36" W or 23" D x 42" W rectangular main worksurfaces only 								

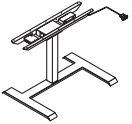

NAVIYD

PRODUCT SPECIFICATIONS

- 3mm rim on all 4 sides of worksurfaces
- Grain direction runs with the width of the surface
- Refer to page 336 for grommet locations and options
- See pages 749-792 for accessories
- Base selection must be specified separately; see pages 338-341 for base options

TO ORDER, SPECIFY:

1. Model Number
2. Rim Color
3. Grommet/Cutout Option
4. Laminate Color

SAMPLE MODEL NUMBER:

65N2971WSSLL 405 G1L 405

- See pages 335-337 for all options available in Naviyd

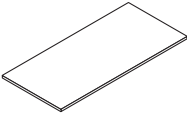
	MODEL NO./DESCRIPTION	LIST PRICE	DIMENSIONS					CARTONED WEIGHT	CUBIC FEET
			D	W	H	A	KW		
RECTANGULAR MAIN WORKSURFACE 29" DEEP 	65N2971WSSLL HPL	\$ 856	29	71 $\frac{3}{8}$	1 $\frac{3}{8}$	—	—	79.57 lbs.	3.31
	65N2971WSSLL TFL	642	29	71 $\frac{3}{8}$	1 $\frac{3}{8}$	—	—	79.57 lbs.	3.31
	65N2965WSSLL HPL	\$ 833	29	65 $\frac{3}{8}$	1 $\frac{3}{8}$	—	—	66.90 lbs.	3.05
	65N2965WSSLL TFL	620	29	65 $\frac{3}{8}$	1 $\frac{3}{8}$	—	—	66.90 lbs.	3.05
	65N2959WSSLL HPL	\$ 689	29	59 $\frac{3}{8}$	1 $\frac{3}{8}$	—	—	66.29 lbs.	2.79
	65N2959WSSLL TFL	533	29	59 $\frac{3}{8}$	1 $\frac{3}{8}$	—	—	66.29 lbs.	2.79
	65N2953WSSLL HPL	\$ 663	29	53 $\frac{3}{8}$	1 $\frac{3}{8}$	—	—	56.10 lbs.	2.57
	65N2953WSSLL TFL	494	29	53 $\frac{3}{8}$	1 $\frac{3}{8}$	—	—	56.10 lbs.	2.57
	65N2947WSSLL HPL	\$ 600	29	47 $\frac{3}{8}$	1 $\frac{3}{8}$	—	—	53.36 lbs.	2.27
	65N2947WSSLL TFL	450	29	47 $\frac{3}{8}$	1 $\frac{3}{8}$	—	—	53.36 lbs.	2.27

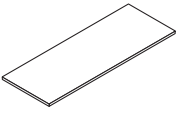
RECTANGULAR MAIN WORKSURFACE 23" DEEP 	65N2371WSSLL HPL	\$ 731	23	71 $\frac{3}{8}$	1 $\frac{3}{8}$	—	—	63.93 lbs.	2.74
	65N2371WSSLL TFL	542	23	71 $\frac{3}{8}$	1 $\frac{3}{8}$	—	—	63.93 lbs.	2.74
	65N2365WSSLL HPL	\$ 710	23	65 $\frac{3}{8}$	1 $\frac{3}{8}$	—	—	53.70 lbs.	2.53
	65N2365WSSLL TFL	529	23	65 $\frac{3}{8}$	1 $\frac{3}{8}$	—	—	53.70 lbs.	2.53
	65N2359WSSLL HPL	\$ 612	23	59 $\frac{3}{8}$	1 $\frac{3}{8}$	—	—	53.26 lbs.	2.31
	65N2359WSSLL TFL	459	23	59 $\frac{3}{8}$	1 $\frac{3}{8}$	—	—	53.26 lbs.	2.31
	65N2353WSSLL HPL	\$ 563	23	53 $\frac{3}{8}$	1 $\frac{3}{8}$	—	—	44.00 lbs.	2.10
	65N2353WSSLL TFL	421	23	53 $\frac{3}{8}$	1 $\frac{3}{8}$	—	—	44.00 lbs.	2.10
	65N2347WSSLL HPL	\$ 508	23	47 $\frac{3}{8}$	1 $\frac{3}{8}$	—	—	42.88 lbs.	1.90
	65N2347WSSLL TFL	379	23	47 $\frac{3}{8}$	1 $\frac{3}{8}$	—	—	42.88 lbs.	1.90
	65N2341WSSLL HPL	\$ 458	23	41 $\frac{3}{8}$	1 $\frac{3}{8}$	—	—	38.60 lbs.	1.80
	65N2341WSSLL TFL	342	23	41 $\frac{3}{8}$	1 $\frac{3}{8}$	—	—	38.60 lbs.	1.80
	65N2335WSSLL HPL	\$ 401	23	35 $\frac{3}{8}$	1 $\frac{3}{8}$	—	—	32.87 lbs.	1.80
	65N2335WSSLL TFL	302	23	35 $\frac{3}{8}$	1 $\frac{3}{8}$	—	—	32.87 lbs.	1.80

PRODUCT SPECIFICATIONS

- 3mm rim on all 4 sides of worksurfaces
- Grain direction runs with the depth of the surface (front to back)
- Refer to page 336 for grommet locations and options
- See pages 749-792 for accessories
- Paired with main worksurfaces to create an L-configuration
- Base selection must be specified separately; see pages 338-341 for base options

TO ORDER, SPECIFY:

1. Model Number
2. Rim Color
3. Grommet/Cutout Option
4. Laminate Color

SAMPLE MODEL NUMBER:

65N2971WSSLL 405 G1L 405

- See pages 335-337 for all options available in Naviyd

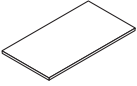
	MODEL NO./DESCRIPTION	LIST PRICE	DIMENSIONS					CARTONED WEIGHT	CUBIC FEET
			D	W	H	A	KW		
RECTANGULAR RETURN WORKSURFACE 23" DEEP 	65N2347WSSVL HPL	\$ 508	23	47 $\frac{1}{2}$	1 $\frac{1}{2}$	–	–	44.09 lbs.	2.4
	65N2347WSSVLL TFL	379	23	47 $\frac{1}{2}$	1 $\frac{1}{2}$	–	–	44.09 lbs.	2.4
	65N2341WSSVL HPL	\$ 458	23	41 $\frac{1}{2}$	1 $\frac{1}{2}$	–	–	38.60 lbs.	2.1
	65N2341WSSVLL TFL	342	23	41 $\frac{1}{2}$	1 $\frac{1}{2}$	–	–	38.60 lbs.	2.1
	65N2335WSSVL HPL	\$ 401	23	35 $\frac{1}{2}$	1 $\frac{1}{2}$	–	–	32.87 lbs.	1.8
	65N2335WSSVLL TFL	302	23	35 $\frac{1}{2}$	1 $\frac{1}{2}$	–	–	32.87 lbs.	1.8

- 23" deep non-handed return worksurfaces; can be set up as right or left return

NAVIYD

PRODUCT SPECIFICATIONS

- 3mm rim on all sides of worksurfaces
- Grain direction runs diagonally
- Refer to page 336 for grommet locations and options
- 120° curved corner surfaces can be paired with T-leg bases only; see pages 338-339
- See pages 749-792 for accessories

TO ORDER, SPECIFY:

1. Model Number
2. Rim Color
3. Grommet/Cutout Option
4. Laminate Color

SAMPLE MODEL NUMBER:

65N4747WSCYCLL2 405 G1C 405

- See pages 335-337 for all options available in Naviyd

	MODEL NO./DESCRIPTION	LIST PRICE	DIMENSIONS					CARTONED CUBIC	
			D	W	H	A	KW	WEIGHT	FEET
120° CURVED CORNER WORKSURFACE	65N4747WSCYCL2 HPL	\$ 1391	43%	82	1 $\frac{3}{8}$	—	—	149 lbs.	5.42
	65N4747WSCYCLL2 TFL	1256	43%	82	1 $\frac{3}{8}$	—	—	149 lbs.	5.42

- Pair with T-leg bases only

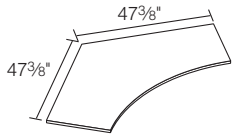

PRODUCT SPECIFICATIONS

- 3mm rim on all sides of worksurfaces
- Grain direction runs with the width of the surface
- Refer to page 336 for grommet locations and options
- Not intended to be paired with a return
- See pages 749-792 for accessories

TO ORDER, SPECIFY:

1. Model Number
2. Rim Color
3. Grommet/Cutout Option
4. Laminate Color

SAMPLE MODEL NUMBER:

65N4771WSCERLL2 405 G1C 405

- See pages 335-337 for all options available in Naviyd

	MODEL NO./DESCRIPTION	LIST PRICE	DIMENSIONS					CARTONED WEIGHT	CUBIC FEET
			D	W	H	A	KW		
EXTENDED CORNER STRAIGHT WORKSURFACE	65N4771WSCERL2 HPL, Right	\$ 1332	47%	71%	1 ¹ / ₆	—	—	46.63 lbs.	70.63
	65N4771WSCERLL2 TFL, Right	1036	46%	70%	1%	—	—	46.63 lbs.	70.63
	65N4771WSCCELL2 HPL, Left	\$ 1332	49%	73%	1 ¹ / ₆	—	—	46.63 lbs.	70.63
	65N4771WSCCELLL2 TFL, Left	1036	48%	72%	1%	—	—	46.63 lbs.	70.63

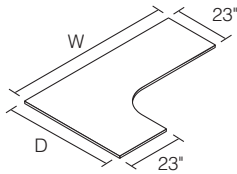

Right shown

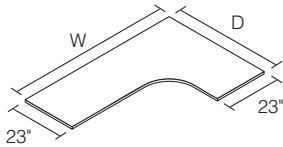

Left shown

EXTENDED CORNER COVE STRAIGHT WORKSURFACE

65N4771WSCVERL2 HPL, Right	\$ 1332	47%	71%	1 ¹ / ₆	—	—	46.63 lbs.	70.63
65N4771WSCVERLL2 TFL, Right	1036	46%	70%	1%	—	—	46.63 lbs.	70.63
65N4771WSCVELL2 HPL, Left	\$ 1332	49%	73%	1 ¹ / ₆	—	—	46.63 lbs.	70.63
65N4771WSCVELLL2 TFL, Left	1036	48%	72%	1%	—	—	46.63 lbs.	70.63

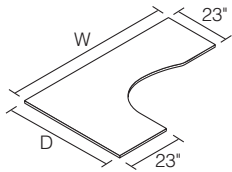

Right shown

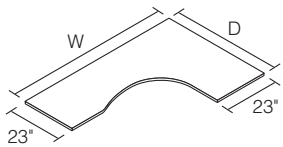

Left shown

NAVIYD

PRODUCT SPECIFICATIONS

- Base includes control box, 9' power cord, and standard up/down control switch
- Desk ships ready to assemble with appropriate hardware
- Refer to page 336 for grommet locations and options
- 3mm rim on all sides of worksurface
- U.L. 1286/962 listed
- Grain direction runs with the width of the surface

TO ORDER, SPECIFY:

1. Model Number
2. Rim Color
3. Grommet/Cutout Option
4. Laminate Color
5. Paint

SAMPLE MODEL NUMBER:

- 65N2971DASTL 405 G1C 405 501
- See pages 335-337 for all options available in Naviyd

	MODEL NO./DESCRIPTION		LIST PRICE	DIMENSIONS					CARTONED CUBIC	
				D	W	H	A	KW	WEIGHT	FEET
CONFIGURED DESKS 29" DEEP RECTANGULAR WORKSURFACE T-LEG STANDARD HEIGHT ADJUSTABLE BASE	65N2971DASTL	HPL	\$ 2262	29	71%	26-42½"	—	—	140.58 lbs.	6.02
	65N2971DASTLL	TFL	2048	29	71%	26-42½"	—	—	140.58 lbs.	6.02
	65N2965DASTL	HPL	\$ 2239	29	65%	26-42½"	—	—	127.91 lbs.	5.75
	65N2965DASTLL	TFL	2026	29	65%	26-42½"	—	—	127.91 lbs.	5.75
	65N2959DASTL	HPL	\$ 2095	29	59%	26-42½"	—	—	127.30 lbs.	5.49
	65N2959DASTLL	TFL	1939	29	59%	26-42½"	—	—	127.30 lbs.	5.49
	65N2953DASTL	HPL	\$ 2069	29	53%	26-42½"	—	—	117.11 lbs.	5.27
	65N2953DASTLL	TFL	1900	29	53%	26-42½"	—	—	117.11 lbs.	5.27
	65N2947DASTL	HPL	\$ 2006	29	47%	26-42½"	—	—	114.37 lbs.	4.97
	65N2947DASTLL	TFL	1856	29	47%	26-42½"	—	—	114.37 lbs.	4.97

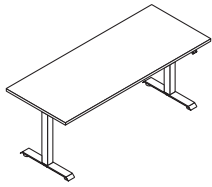

- Maximum surface weight with caster option is 130 pounds
- Caster options listed on page 358
- Standard height adjustable 24¼"-41½"
- Black plastic glides are standard; 2" diameter and adjustable range ½"
- Memory control and programmable switches available; see page 358
- Pedestals, overhead storage or components should not be installed in the path of the height adjustable desks
- Frames are adjustable in 6" increments
- Base feet are 23¾" deep
- TFL surfaces are 1½" thick and HPL surfaces are 1¾" thick

CONFIGURED DESKS 23" DEEP RECTANGULAR WORKSURFACE T-LEG STANDARD HEIGHT ADJUSTABLE BASE	65N2371DASTL	HPL	\$ 2137	23	71%	26-42½"	—	—	124.94 lbs.	5.44
	65N2371DASTLL	TFL	1948	23	71%	26-42½"	—	—	124.94 lbs.	5.44
	65N2365DASTL	HPL	\$ 2116	23	65%	26-42½"	—	—	114.71 lbs.	5.23
	65N2365DASTLL	TFL	1935	23	65%	26-42½"	—	—	114.71 lbs.	5.23
	65N2359DASTL	HPL	\$ 2018	23	59%	26-42½"	—	—	114.27 lbs.	5.02
	65N2359DASTLL	TFL	1865	23	59%	26-42½"	—	—	114.27 lbs.	5.02
	65N2353DASTL	HPL	\$ 1969	23	53%	26-42½"	—	—	105.01 lbs.	4.80
	65N2353DASTLL	TFL	1827	23	53%	26-42½"	—	—	105.01 lbs.	4.80
	65N2347DASTL	HPL	\$ 1914	23	47%	26-42½"	—	—	103.89 lbs.	4.60
	65N2347DASTLL	TFL	1785	23	47%	26-42½"	—	—	103.89 lbs.	4.60

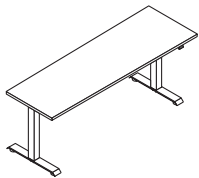

- Maximum surface weight with caster option is 130 pounds
- Caster options listed on page 358
- Standard height adjustable 24¼"-41½"
- Black plastic glides are standard; 2" diameter and adjustable range ½"
- Memory control and programmable switches available; see page 358
- Pedestals, overhead storage or components should not be installed in the path of the height adjustable desks
- Frames are adjustable in 6" increments
- Base feet are 23¾" deep
- TFL surfaces are 1½" thick and HPL surfaces are 1¾" thick

PRODUCT SPECIFICATIONS

- Base includes control box, 9' power cord, and standard up/down control switch
- Desk ships ready to assemble with appropriate hardware
- Refer to page 336 for grommet locations and options
- 3mm rim on all sides of worksurface
- U.L. 1286/962 listed
- Grain direction runs with the width of the surface

TO ORDER, SPECIFY:

1. Model Number
2. Rim Color
3. Grommet/Cutout Option
4. Laminate Color
5. Paint

SAMPLE MODEL NUMBER:

65N2971DAETL 405 G1C 405 501

- See pages 335-337 for all options available in Naviyd

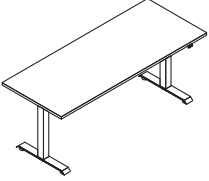
	MODEL NO./DESCRIPTION	LIST PRICE	DIMENSIONS				KW	CARTONED WEIGHT	CUBIC FEET
			D	W	H	A			
CONFIGURED DESKS 29" DEEP RECTANGULAR WORKSURFACE T-LEG EXTENDED HEIGHT ADJUSTABLE BASE 	65N2971DAETL HPL	\$ 2551	29	71%	22½-48½	—	144.58 lbs.	6.02	
	65N2971DAETLL TFL	2337	29	71%	22½-48½	—	144.58 lbs.	6.02	
	65N2965DAETL HPL	\$ 2528	29	65%	22½-48½	—	131.91 lbs.	5.75	
	65N2965DAETLL TFL	2315	29	65%	22½-48½	—	131.91 lbs.	5.75	
	65N2959DAETL HPL	\$ 2384	29	59%	22½-48½	—	131.30 lbs.	5.49	
	65N2959DAETLL TFL	2228	29	59%	22½-48½	—	131.30 lbs.	5.49	
	65N2953DAETL HPL	\$ 2358	29	53%	22½-48½	—	121.11 lbs.	5.27	
	65N2953DAETLL TFL	2189	29	53%	22½-48½	—	121.11 lbs.	5.27	
	65N2947DAETL HPL	\$ 2295	29	47%	22½-48½	—	118.37 lbs.	4.97	
	65N2947DAETLL TFL	2145	29	47%	22½-48½	—	118.37 lbs.	4.97	

- Maximum surface weight with caster option is 130 pounds
- Caster options listed on page 358
- Extended height adjustable 21½"-47¼"
- Black plastic glides are standard; 2" diameter and adjustable range ½"
- Memory control and programmable switches available; see page 358
- Pedestals, overhead storage or components should not be installed in the path of the height adjustable desks
- Frames are adjustable in 6" increments
- Base feet are 23¾" deep
- TFL surfaces are 1½" thick and HPL surfaces are 1¾" thick

CONFIGURED DESKS
23" DEEP RECTANGULAR WORKSURFACE
T-LEG EXTENDED HEIGHT ADJUSTABLE BASE

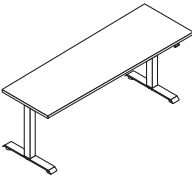

65N2371DAETL HPL	\$ 2426	23	71%	22½-48½	—	128.94 lbs.	5.44
65N2371DAETLL TFL	2237	23	71%	22½-48½	—	128.94 lbs.	5.44
65N2365DAETL HPL	\$ 2405	23	65%	22½-48½	—	118.71 lbs.	5.23
65N2365DAETLL TFL	2224	23	65%	22½-48½	—	118.71 lbs.	5.23
65N2359DAETL HPL	\$ 2307	23	59%	22½-48½	—	118.27 lbs.	5.02
65N2359DAETLL TFL	2154	23	59%	22½-48½	—	118.27 lbs.	5.02
65N2353DAETL HPL	\$ 2258	23	53%	22½-48½	—	109.01 lbs.	4.80
65N2353DAETLL TFL	2116	23	53%	22½-48½	—	109.01 lbs.	4.80
65N2347DAETL HPL	\$ 2203	23	47%	22½-48½	—	107.89 lbs.	4.60
65N2347DAETLL TFL	2074	23	47%	22½-48½	—	107.89 lbs.	4.60

- Maximum surface weight with caster option is 130 pounds
- Caster options listed on page 358
- Extended height adjustable 21½"-47¼"
- Black plastic glides are standard; 2" diameter and adjustable range ½"
- Memory control and programmable switches available; see page 358
- Pedestals, overhead storage or components should not be installed in the path of the height adjustable desks
- Frames are adjustable in 6" increments
- Base feet are 23¾" deep
- TFL surfaces are 1½" thick and HPL surfaces are 1¾" thick

NAVIYD

PRODUCT SPECIFICATIONS

- Base includes control box, 9' power cord, and standard up/down control switch
- Desk ships ready to assemble with appropriate hardware
- Refer to page 336 for grommet locations and options
- 3mm rim on all sides of worksurface
- U.L. 1286/962 listed
- Grain direction runs with the width of the surface

TO ORDER, SPECIFY:

1. Model Number
2. Rim Color
3. Grommet/Cutout Option
4. Laminate Color
5. Paint

SAMPLE MODEL NUMBER:

- 65N2971DASCL 405 G1C 405 501
- See pages 335-337 for all options available in Naviyd

MODEL NO./DESCRIPTION	LIST PRICE	DIMENSIONS				CARTONED WEIGHT	CUBIC FEET
		D	W	H	A		
CONFIGURED DESKS 29" DEEP RECTANGULAR WORKSURFACE C-LEG STANDARD HEIGHT ADJUSTABLE BASE							
65N2971DASCL HPL	\$ 2402	29	71%	26-42½"	—	140.58 lbs.	6.02
65N2971DASCLL TFL	2188	29	71%	26-42½"	—	140.58 lbs.	6.02
65N2965DASCL HPL	\$ 2379	29	65%	26-42½"	—	127.91 lbs.	5.75
65N2965DASCLL TFL	2166	29	65%	26-42½"	—	127.91 lbs.	5.75
65N2959DASCL HPL	\$ 2235	29	59%	26-42½"	—	127.30 lbs.	5.49
65N2959DASCLL TFL	2079	29	59%	26-42½"	—	127.30 lbs.	5.49
65N2953DASCL HPL	\$ 2209	29	53%	26-42½"	—	117.11 lbs.	5.27
65N2953DASCLL TFL	2040	29	53%	26-42½"	—	117.11 lbs.	5.27
65N2947DASCL HPL	\$ 2146	29	47%	26-42½"	—	114.37 lbs.	4.97
65N2947DASCLL TFL	1996	29	47%	26-42½"	—	114.37 lbs.	4.97

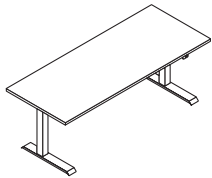

- Not compatible with monitor arms, privacy screens or casters due to tip hazard
- Standard height adjustable 24¼"-41¼"
- Black plastic glides are standard; 2" diameter and adjustable range ½"
- Memory control and programmable switches available; see page 358
- Pedestals, overhead storage or components should not be installed in the path of the height adjustable desks
- Frames are adjustable in 6" increments
- Base feet are 23¾" deep
- TFL surfaces are 1¼" thick and HPL surfaces are 1¾" thick

CONFIGURED DESKS 23" DEEP RECTANGULAR WORKSURFACE C-LEG STANDARD HEIGHT ADJUSTABLE BASE							
65N2371DASCL HPL	\$ 2277	23	71%	26-42½"	—	124.94 lbs.	5.44
65N2371DASCLL TFL	2088	23	71%	26-42½"	—	124.94 lbs.	5.44
65N2365DASCL HPL	\$ 2256	23	65%	26-42½"	—	114.71 lbs.	5.23
65N2365DASCLL TFL	2075	23	65%	26-42½"	—	114.71 lbs.	5.23
65N2359DASCL HPL	\$ 2158	23	59%	26-42½"	—	114.27 lbs.	5.02
65N2359DASCLL TFL	2005	23	59%	26-42½"	—	114.27 lbs.	5.02
65N2353DASCL HPL	\$ 2109	23	53%	26-42½"	—	105.01 lbs.	4.80
65N2353DASCLL TFL	1967	23	53%	26-42½"	—	105.01 lbs.	4.80
65N2347DASCL HPL	\$ 2054	23	47%	26-42½"	—	103.89 lbs.	4.60
65N2347DASCLL TFL	1925	23	47%	26-42½"	—	103.89 lbs.	4.60

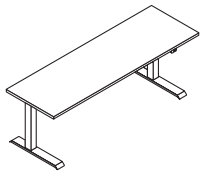

- Not compatible with monitor arms, privacy screens or casters due to tip hazard
- Standard height adjustable 24¼"-41¼"
- Black plastic glides are standard; 2" diameter and adjustable range ½"
- Memory control and programmable switches available; see page 358
- Pedestals, overhead storage or components should not be installed in the path of the height adjustable desks
- Frames are adjustable in 6" increments
- Base feet are 23¾" deep
- TFL surfaces are 1¼" thick and HPL surfaces are 1¾" thick

PRODUCT SPECIFICATIONS

- Base includes control box, 9' power cord, and standard up/down control switch
- Desk ships ready to assemble with appropriate hardware
- Refer to page 336 for grommet locations and options
- 3mm rim on all sides of worksurface
- U.L. 1286/962 listed
- Grain direction runs with the width of the surface

TO ORDER, SPECIFY:

1. Model Number
2. Rim Color
3. Grommet/Cutout Option
4. Laminate Color
5. Paint

SAMPLE MODEL NUMBER:

65N2971DAECL 405 G1C 405 501

- See pages 335-337 for all options available in Naviyd

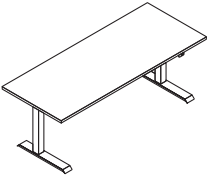
	MODEL NO./DESCRIPTION	LIST PRICE	DIMENSIONS				CARTONED WEIGHT	CUBIC FEET	
			D	W	H	A			KW
CONFIGURED DESKS 29" DEEP RECTANGULAR WORKSURFACE C-LEG EXTENDED HEIGHT ADJUSTABLE BASE 	65N2971DAECL HPL	\$ 2721	29	71%	22½-48½	—	144.58 lbs.	6.02	
	65N2971DAECLL TFL	2507	29	71%	22½-48½	—	144.58 lbs.	6.02	
	65N2965DAECL HPL	\$ 2698	29	65%	22½-48½	—	131.91 lbs.	5.75	
	65N2965DAECLL TFL	2485	29	65%	22½-48½	—	131.91 lbs.	5.75	
	65N2959DAECL HPL	\$ 2554	29	59%	22½-48½	—	131.30 lbs.	5.49	
	65N2959DAECLL TFL	2398	29	59%	22½-48½	—	131.30 lbs.	5.49	
	65N2953DAECL HPL	\$ 2528	29	53%	22½-48½	—	121.11 lbs.	5.27	
	65N2953DAECLL TFL	2359	29	53%	22½-48½	—	121.11 lbs.	5.27	
	65N2947DAECL HPL	\$ 2465	29	47%	22½-48½	—	118.37 lbs.	4.97	
	65N2947DAECLL TFL	2315	29	47%	22½-48½	—	118.37 lbs.	4.97	
	<ul style="list-style-type: none"> • Not compatible with monitor arms, privacy screens or casters due to tip hazard • Extended height adjustable 21½"-47¼" • Black plastic glides are standard; 2" diameter and adjustable range ½" • Memory control and programmable switches available; see page 358 • Pedestals, overhead storage or components should not be installed in the path of the height adjustable desks • Frames are adjustable in 6" increments • Base feet are 23% deep • TFL surfaces are 1% thick and HPL surfaces are 1¾" thick 								

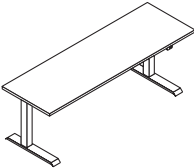
CONFIGURED DESKS 23" DEEP RECTANGULAR WORKSURFACE C-LEG EXTENDED HEIGHT ADJUSTABLE BASE 	65N2371DAECL HPL	\$ 2596	23	71%	22½-48½	—	128.94 lbs.	5.44	
	65N2371DAECLL TFL	2407	23	71%	22½-48½	—	128.94 lbs.	5.44	
	65N2365DAECL HPL	\$ 2575	23	65%	22½-48½	—	118.71 lbs.	5.23	
	65N2365DAECLL TFL	2394	23	65%	22½-48½	—	118.71 lbs.	5.23	
	65N2359DAECL HPL	\$ 2477	23	59%	22½-48½	—	118.27 lbs.	5.02	
	65N2359DAECLL TFL	2324	23	59%	22½-48½	—	118.27 lbs.	5.02	
	65N2353DAECL HPL	\$ 2428	23	53%	22½-48½	—	109.01 lbs.	4.80	
	65N2353DAECLL TFL	2286	23	53%	22½-48½	—	109.01 lbs.	4.80	
	65N2347DAECL HPL	\$ 2373	23	47%	22½-48½	—	107.89 lbs.	4.60	
	65N2347DAECLL TFL	2244	23	47%	22½-48½	—	107.89 lbs.	4.60	
	<ul style="list-style-type: none"> • Not compatible with monitor arms, privacy screens or casters due to tip hazard • Extended height adjustable 21½"-47¼" • Black plastic glides are standard; 2" diameter and adjustable range ½" • Memory control and programmable switches available; see page 358 • Pedestals, overhead storage or components should not be installed in the path of the height adjustable desks • Frames are adjustable in 6" increments • Base feet are 23% deep • TFL surfaces are 1% thick and HPL surfaces are 1¾" thick 								

NAVIYD

PRODUCT SPECIFICATIONS

- Base includes control box, 9' power cord, and standard up/down control switch
- Desk ships ready to assemble with appropriate hardware
- Refer to page 336 for grommet locations and options
- 3mm rim on all sides of worksurface
- U.L. 1286/962 listed
- Grain direction runs with the width of the surface

TO ORDER, SPECIFY:

1. Model Number
2. Rim Color
3. Grommet/Cutout Option
4. Laminate Color
5. Paint

SAMPLE MODEL NUMBER:

65N2342DASHL 405 G1C 405 501
 • See pages 335-337 for all options available in Naviyd

	MODEL NO./DESCRIPTION	LIST PRICE	DIMENSIONS					CARTONED CUBIC	
			D	W	H	A	KW	WEIGHT	FEET
CONFIGURED DESKS 23" DEEP RECTANGULAR WORKSURFACE SINGLE-COLUMN H STANDARD HEIGHT ADJUSTABLE BASE	65N2342DASHL HPL	\$ 1672	23	42	26-42¼"		—	87.55 lbs.	6.18
	65N2342DASHLL TFL	1556	23	42	26-42¼"		—	87.55 lbs.	6.18
	65N2336DASHL HPL	\$ 1615	23	36	26-42¼"		—	82.22 lbs.	5.97
	65N2336DASHLL TFL	1516	23	36	26-42¼"		—	82.22 lbs.	5.97

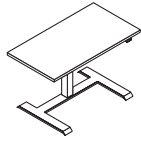

- Standard height adjustable 24¾"-41¾"
- Black plastic glides are standard; 2" diameter and adjustable range ½"
- Memory control and programmable switches available; see page 358
- Pedestals, overhead storage or components should not be installed in the path of the height adjustable desks
- Fixed frame width
- Can be paired with 23" D x 36" W or 23" D x 42" W rectangular main worksurfaces only

PRODUCT SPECIFICATIONS

- Base includes control box, 9' power cord, and standard up/down control switch
- Desk ships ready to assemble with appropriate hardware
- Refer to page 336 for grommet locations and options
- 3mm rim on all sides of worksurface
- U.L. 1286/962 listed
- Grain direction runs with the width of the main surface and the depth of return surface
- 23" wide non-handed return worksurfaces; can be set up as right or left return

TO ORDER, SPECIFY:

1. Model Number
2. Rim Color
3. Grommet/Cutout Option
4. Laminate Color
5. Paint

SAMPLE MODEL NUMBER:

65N297171DALSTL 405 G1C 405 501

- See pages 335-337 for all options available in Naviyd

	MODEL NO./DESCRIPTION	LIST PRICE	DIMENSIONS				CARTONED WEIGHT	CUBIC FEET	
			D	W	H	A			KW
CONFIGURED DESKS MAIN & RETURN WORKSURFACE T-LEG L-CONFIGURATION STANDARD HEIGHT ADJUSTABLE BASE	29" DEEP MAIN SURFACE 72" WIDE		OVERALL RETURN MAIN		D W H A		H		
	65N297171DALSTL	HPL	\$ 3702	71%	42%	71%	26-42 1/4"	231.12 lbs.	9.15
	65N297171DALSTLL	TFL	3359	71%	42%	71%	26-42 1/4"	231.12 lbs.	9.15
	65N296571DALSTL	HPL	\$ 3679	65%	36%	71%	26-42 1/4"	225.79 lbs.	8.94
	65N296571DALSTLL	TFL	3337	65%	36%	71%	26-42 1/4"	225.79 lbs.	8.94
	60" WIDE								
	65N297159DALSTL	HPL	\$ 3595	71%	42%	59%	26-42 1/4"	217.84 lbs.	8.63
	65N297159DALSTLL	TFL	3282	71%	42%	59%	26-42 1/4"	217.84 lbs.	8.63
	65N296559DALSTL	HPL	\$ 3572	65%	36%	59%	26-42 1/4"	212.51 lbs.	8.42
	65N296559DALSTLL	TFL	3260	65%	36%	59%	26-42 1/4"	212.51 lbs.	8.42

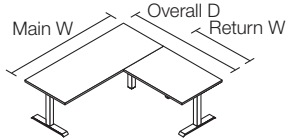

- Standard height adjustable 24 3/4"-41 1/2"
- Black plastic glides are standard; 2" diameter and adjustable range 1/2"
- Memory control and programmable switches available; see page 358
- Pedestals, overhead storage or components should not be installed in the path of the height adjustable desks
- Frames are adjustable in 6" increments
- Base feet are 23 3/8" deep
- TFL surfaces are 1 1/8" thick and HPL surfaces are 1 3/16" thick

NAVIYD

PRODUCT SPECIFICATIONS

- Base includes control box, 9' power cord, and standard up/down control switch
- Desk ships ready to assemble with appropriate hardware
- Refer to page 336 for grommet locations and options
- 3mm rim on all sides of worksurface
- U.L. 1286/962 listed
- Grain direction runs with the width of the main surface and the depth of return surface
- 23" wide non-handed return worksurfaces; can be set up as right or left return

TO ORDER, SPECIFY:

1. Model Number
2. Rim Color
3. Grommet/Cutout Option
4. Laminate Color
5. Paint

SAMPLE MODEL NUMBER:

- 65N237171DALSTL 405 G1C 405 501
- See pages 335-337 for all options available in Naviyd

	MODEL NO./DESCRIPTION	LIST PRICE	DIMENSIONS				CARTONED CUBIC	
			D	W	H	A	KW	WEIGHT
CONFIGURED DESKS MAIN & RETURN WORKSURFACE T-LEG L-CONFIGURATION STANDARD HEIGHT ADJUSTABLE BASE (CONTINUED)	23" DEEP MAIN SURFACE 72" WIDE		OVERALL D	RETURN W	MAIN W	A	KW	
	65N237171DALSTL HPL	\$ 3577	71%	48%	71%	26-42 1/4"	221.51 lbs.	8.78
	65N237171DALSTLL TFL	3259	71%	48%	71%	26-42 1/4"	221.51 lbs.	8.78
	65N236571DALSTL HPL	\$ 3556	65%	42%	71%	26-42 1/4"	215.48 lbs.	8.58
	65N236571DALSTLL TFL	3246	65%	42%	71%	26-42 1/4"	215.48 lbs.	8.58
	65N235971DALSTL HPL	\$ 3458	59%	36%	71%	26-42 1/4"	210.15 lbs.	8.37
	65N235971DALSTLL TFL	3176	59%	36%	71%	26-42 1/4"	210.15 lbs.	8.37
	60" WIDE							
	65N237159DALSTL HPL	\$ 3470	71%	48%	59%	26-42 1/4"	210.84 lbs.	8.36
	65N237159DALSTLL TFL	3182	71%	48%	59%	26-42 1/4"	210.84 lbs.	8.36
	65N236559DALSTL HPL	\$ 3449	65%	42%	59%	26-42 1/4"	204.81 lbs.	8.15
	65N236559DALSTLL TFL	3169	65%	42%	59%	26-42 1/4"	204.81 lbs.	8.15
65N235959DALSTL HPL	\$ 3351	59%	36%	59%	26-42 1/4"	199.48 lbs.	7.94	
65N235959DALSTLL TFL	3099	59%	36%	59%	26-42 1/4"	199.48 lbs.	7.94	

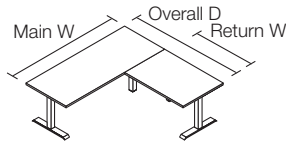

- Standard height adjustable 24 3/4"-41 1/2"
- Black plastic glides are standard; 2" diameter and adjustable range 1/2"
- Memory control and programmable switches available; see page 358
- Pedestals, overhead storage or components should not be installed in the path of the height adjustable desks
- Frames are adjustable in 6" increments
- Base feet are 23 3/8" deep
- TFL surfaces are 1 1/8" thick and HPL surfaces are 1 3/16" thick

PRODUCT SPECIFICATIONS

- Base includes control box, 9' power cord, and standard up/down control switch
- Desk ships ready to assemble with appropriate hardware
- Refer to page 336 for grommet locations and options
- 3mm rim on all sides of worksurface
- U.L. 1286/962 listed
- Grain direction runs with the width of the main surface and the depth of return surface
- 23" wide non-handed return worksurfaces; can be set up as right or left return

TO ORDER, SPECIFY:

1. Model Number
2. Rim Color
3. Grommet/Cutout Option
4. Laminate Color
5. Paint

SAMPLE MODEL NUMBER:

65N297171DALETL 405 G1C 405 501

- See pages 335-337 for all options available in Naviyd

	MODEL NO./DESCRIPTION	LIST PRICE	DIMENSIONS				KW	CARTONED WEIGHT	CUBIC FEET
			D	W	H	A			
CONFIGURED DESKS MAIN & RETURN WORKSURFACE T-LEG L-CONFIGURATION EXTENDED HEIGHT ADJUSTABLE BASE	29" DEEP MAIN SURFACE 72" WIDE		OVERALL D	RETURN W	MAIN W	H			
	65N297171DALETL	HPL	\$ 3749	71%	42%	71%	22½-48½	231.12 lbs.	9.15
	65N297171DALETLL	TFL	3406	71%	42%	71%	22½-48½	231.12 lbs.	9.15
	65N296571DALETL	HPL	\$ 3726	65%	36%	71%	22½-48½	225.79 lbs.	8.94
	65N296571DALETLL	TFL	3384	65%	36%	71%	22½-48½	225.79 lbs.	8.94
	60" WIDE								
	65N297159DALETL	HPL	\$ 3642	71%	42%	59%	22½-48½	217.84 lbs.	8.63
	65N297159DALETLL	TFL	3329	71%	42%	59%	22½-48½	217.84 lbs.	8.63
	65N296559DALETL	HPL	\$ 3619	65%	36%	59%	22½-48½	212.51 lbs.	8.42
	65N296559DALETLL	TFL	3307	65%	36%	59%	22½-48½	212.51 lbs.	8.42

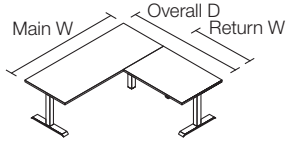

- Extended height adjustable 21½"-47¼"
- Black plastic glides are standard; 2" diameter and adjustable range ½"
- Memory control and programmable switches available; see page 358
- Pedestals, overhead storage or components should not be installed in the path of the height adjustable desks
- Frames are adjustable in 6" increments
- Base feet are 23½" deep
- TFL surfaces are 1½" thick and HPL surfaces are 1¾" thick

NAVIYD

PRODUCT SPECIFICATIONS

- Base includes control box, 9' power cord, and standard up/down control switch
- Desk ships ready to assemble with appropriate hardware
- Refer to page 336 for grommet locations and options
- 3mm rim on all sides of worksurface
- U.L. 1286/962 listed
- Grain direction runs with the width of the main surface and the depth of return surface
- 23" wide non-handed return worksurfaces; can be set up as right or left return

TO ORDER, SPECIFY:

1. Model Number
2. Rim Color
3. Grommet/Cutout Option
4. Laminate Color
5. Paint

SAMPLE MODEL NUMBER:

- 65N237171DALETL 405 G1C 405 501
- See pages 335-337 for all options available in Naviyd

MODEL NO./DESCRIPTION	LIST PRICE	DIMENSIONS				CARTONED CUBIC		
		D	W	H	A	KW	WEIGHT	FEET
CONFIGURED DESKS MAIN & RETURN WORKSURFACE T-LEG L-CONFIGURATION EXTENDED HEIGHT ADJUSTABLE BASE (CONTINUED)		23" DEEP MAIN SURFACE 72" WIDE	OVERALL D	RETURN W	MAIN W	H		
65N237171DALETL HPL	\$ 3624		71%	48%	71%	22½-48½	221.51 lbs.	8.78
65N237171DALETLL TFL	3306		71%	48%	71%	22½-48½	221.51 lbs.	8.78
65N236571DALETL HPL	\$ 3603		65%	42%	71%	22½-48½	215.48 lbs.	8.58
65N236571DALETLL TFL	3293		65%	42%	71%	22½-48½	215.48 lbs.	8.58
65N235971DALETL HPL	\$ 3505		59%	36%	71%	22½-48½	210.15 lbs.	8.37
65N235971DALETLL TFL	3223		59%	36%	71%	22½-48½	210.15 lbs.	8.37
		60" WIDE						
65N237159DALETL HPL	\$ 3517		71%	48%	59%	22½-48½	210.84 lbs.	8.36
65N237159DALETLL TFL	3229		71%	48%	59%	22½-48½	210.84 lbs.	8.36
65N236559DALETL HPL	\$ 3496		65%	42%	59%	22½-48½	204.81 lbs.	8.15
65N236559DALETLL TFL	3216		65%	42%	59%	22½-48½	204.81 lbs.	8.15
65N235959DALETL HPL	\$ 3398		59%	36%	59%	22½-48½	199.48 lbs.	7.94
65N235959DALETLL TFL	3146		59%	36%	59%	22½-48½	199.48 lbs.	7.94

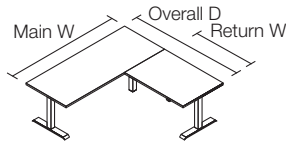

- Extended height adjustable 21½"-47¼"
- Black plastic glides are standard; 2" diameter and adjustable range ½"
- Memory control and programmable switches available; see page 358
- Pedestals, overhead storage or components should not be installed in the path of the height adjustable desks
- Frames are adjustable in 6" increments
- Base feet are 23½" deep
- TFL surfaces are 1½" thick and HPL surfaces are 1¾" thick

PRODUCT SPECIFICATIONS

- Base includes control box, 9' power cord, and standard up/down control switch
- Desk ships ready to assemble with appropriate hardware
- Refer to page 336 for grommet locations and options
- 3mm rim on all sides of worksurface
- U.L. 1286/962 listed
- Grain direction runs with the width of the surface

TO ORDER, SPECIFY:

1. Model Number
2. Rim Color
3. Grommet/Cutout Option
4. Laminate Color
5. Paint

SAMPLE MODEL NUMBER:

65N4771DACERETL2 405 G1C 405 501
 • See pages 335-337 for all options available in Naviyd

MODEL NO./DESCRIPTION	LIST PRICE	DIMENSIONS					CARTONED WEIGHT	CUBIC FEET	
		D	W	H	A	KW			
CONFIGURED DESKS									
EXTENDED CORNER									
STRAIGHT WORKSURFACE									
T-LEG ADJUSTABLE BASE									
EXTENDED HEIGHT									
	LEFT								
	RIGHT								
65N4771DACELETLL2	65N4771DACERETL2	HPL	\$ 3717	46%	70%	22½-48½	—	213.01 lbs.	9.97
65N4771DACELETLL2	65N4771DACERETLL2	TFL	3421	46%	70%	22½-48½	—	213.01 lbs.	9.97

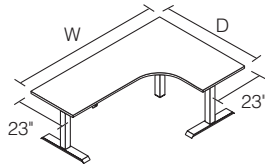

Left shown

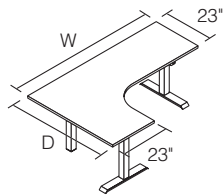

Right shown

STANDARD HEIGHT

LEFT

RIGHT

65N4771DACESTLL2	65N4771DACERSTL2	HPL	\$ 3570	46%	70%	26-42¼	—	213.01 lbs.	9.97
65N4771DACESTLL2	65N4771DACERSTLL2	TFL	3274	46%	70%	26-42¼	—	213.01 lbs.	9.97

- Extended height adjustable 21¾"-47¼"
- Standard height adjustable 24¾"-41¾"
- Black plastic glides are standard; 2" diameter and adjustable range ½"
- Memory control and programmable switches available; see page 358
- Pedestals, overhead storage or components should not be installed in the path of the height adjustable desks
- Frames are adjustable in 6" increments
- Base feet are 23¾" deep
- TFL surfaces are 1¼" thick and HPL surfaces are 1¾" thick

NAVIYD

PRODUCT SPECIFICATIONS

- Base includes control box, 9' power cord, and standard up/down control switch
- Desk ships ready to assemble with appropriate hardware
- Refer to page 336 for grommet locations and options
- 3mm rim on all sides of worksurface
- U.L. 1286/962 listed
- Grain direction runs with the width of the surface

TO ORDER, SPECIFY:

1. Model Number
2. Rim Color
3. Grommet/Cutout Option
4. Laminate Color
5. Paint

SAMPLE MODEL NUMBER:

- 65N4771DACVRETL2 405 G1C 405 501
- See pages 335-337 for all options available in Naviyd

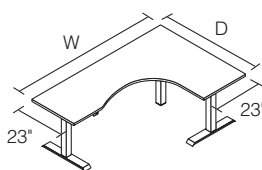
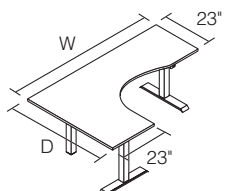
CONFIGURED DESKS EXTENDED COVE WORKSURFACE T-LEG ADJUSTABLE BASE	MODEL NO./DESCRIPTION		LIST PRICE	DIMENSIONS					CARTONED CUBIC	
	LEFT	RIGHT		D	W	H	A	KW	WEIGHT	FEET
 <p>Left shown</p>	65N4771DACVLETL2	65N4771DACVRETL2	HPL	\$ 3717	46%	70%	22½-48½	—	213.01 lbs.	9.97
	65N4771DACVLETL2	65N4771DACVRETL2	TFL	3421	46%	70%	22½-48½	—	213.01 lbs.	9.97
 <p>Right shown</p>	65N4771DACVLSTL2	65N4771DACVRSTL2	HPL	\$ 3570	46%	70%	26-42¼	—	213.01 lbs.	9.97
	65N4771DACVLSTL2	65N4771DACVRSTL2	TFL	3274	46%	70%	26-42¼	—	213.01 lbs.	9.97

STANDARD HEIGHT

LEFT

RIGHT

65N4771DACVLSTL2	65N4771DACVRSTL2	HPL	\$ 3570	46%	70%	26-42¼	—	213.01 lbs.	9.97
65N4771DACVLSTL2	65N4771DACVRSTL2	TFL	3274	46%	70%	26-42¼	—	213.01 lbs.	9.97

- Extended height adjustable 21¾"-47¼"
- Standard height adjustable 24¾"-41¾"
- Black plastic glides are standard; 2" diameter and adjustable range ½"
- Memory control and programmable switches available; see page 358
- Pedestals, overhead storage or components should not be installed in the path of the height adjustable desks
- Frames are adjustable in 6" increments
- Base feet are 23¾" deep
- TFL surfaces are 1¼" thick and HPL surfaces are 1¾" thick

PRODUCT SPECIFICATIONS

- Base includes control box, 9' power cord, and standard up/down control switch
- Desk ships ready to assemble with appropriate hardware
- Refer to page 336 for grommet locations and options
- 3mm rim on all sides of worksurface
- U.L. 1286/962 listed
- Grain direction runs diagonally

TO ORDER, SPECIFY:

1. Model Number
2. Rim Color
3. Grommet/Cutout Option
4. Laminate Color
5. Paint

SAMPLE MODEL NUMBER:

65N4747DACYCETL2 405 G1C 405 501

- See pages 335-337 for all options available in Naviyd

	MODEL NO./DESCRIPTION	LIST PRICE	DIMENSIONS					CARTONED WEIGHT	CUBIC FEET
			D	W	H	A	KW		
CONFIGURED DESKS 120° CURVED CORNER WORKSURFACE T-LEG ADJUSTABLE BASE	23" DEEP MAIN WORKSURFACE EXTENDED HEIGHT								
	65N4747DACYCETL2	HPL	\$ 3086	42 $\frac{3}{8}$	82	26-42 $\frac{1}{4}$	—	214.01 lbs.	8.13
	65N4747DACYCETLL2	TFL	2951	42 $\frac{3}{8}$	82	26-42 $\frac{1}{4}$	—	214.01 lbs.	8.13
	STANDARD HEIGHT								
	65N4747DACYCSTL2	HPL	\$ 2797	42 $\frac{3}{8}$	82	22 $\frac{1}{2}$ -48 $\frac{1}{2}$	—	210.01 lbs.	8.13
	65N4747DACYCSTLL2	TFL	2662	42 $\frac{3}{8}$	82	22 $\frac{1}{2}$ -48 $\frac{1}{2}$	—	210.01 lbs.	8.13

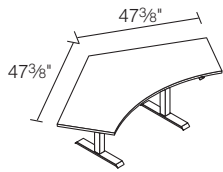

- Extended height adjustable 21 $\frac{3}{8}$ "-47 $\frac{3}{4}$ "
- Standard height adjustable 24 $\frac{3}{4}$ "-41 $\frac{1}{8}$ "
- Black plastic glides are standard; 2" diameter and adjustable range $\frac{1}{2}$ "
- Memory control and programmable switches available; see page 358
- Pedestals, overhead storage or components should not be installed in the path of the height adjustable desks
- Frames are adjustable in 6" increments
- Base feet are 23 $\frac{3}{8}$ " deep
- TFL surfaces are 1 $\frac{1}{8}$ " thick and HPL surfaces are 1 $\frac{3}{16}$ " thick

NAVIYD

PRODUCT SPECIFICATIONS

- Refer to planning pages 333-334 for additional information
- Ships with all hardware; field installed

TO ORDER, SPECIFY:

1. Model Number

SAMPLE MODEL NUMBER:

NAC04MCONB

- See pages 335-337 for all options available in Naviyd

	MODEL NO./DESCRIPTION	LIST PRICE	DIMENSIONS					CARTONED WEIGHT	CUBIC FEET
			D	W	H	A	KW		
MEMORY CONTROL SWITCH	NAC04MCONB	\$ 175	2½	4½	1	—	—	0.1 lbs.	0.10



- Includes display screen
- Operates the same as standard up/down switch
- Memory control switch allows the user to set a specific high/low position
- See Casegoods Book 2 price list for the 4 Position Programmable Memory Control Option

BLACK PLASTIC CASTERS

65NCSTB	Set of 4	\$ 85	1½	2	2½	—	—	1.5 lbs.	0.46
---------	----------	-------	----	---	----	---	---	----------	------



- Brake lever extends from caster, adding ¼" to depth
- Caster adds 1½" to over-all height of table
- For use with 23" deep rectangular worksurfaces and T-leg bases only
- When casters are used, maximum weight for desk is 130 pounds

PRODUCT SPECIFICATIONS

- See planning pages 333-334 for additional information
- 48" wide includes two mounting brackets; 54"-72" wide includes three mounting brackets
- Pairable with rectangular main, extended straight, and cove worksurfaces
- Attachment hardware included

TO ORDER, SPECIFY:

1. Model Number
2. Laminate Color (omit for Resin)

SAMPLE MODEL NUMBER:

65N7110MPLL 405

- See pages 335-337 for all options available in Naviyd

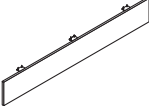
	MODEL NO./DESCRIPTION	LIST PRICE	DIMENSIONS					CARTONED CUBIC	
			D	W	H	A	KW	WEIGHT	FEET
	65N7110MPA	\$ 754	¾	71¾	10	–	–	19.81 lbs.	1.8
	65N6510MPA	710	¾	65¾	10	–	–	18.30 lbs.	1.7
	65N5910MPA	665	¾	59¾	10	–	–	17.53 lbs.	1.5
	65N5310MPA	623	¾	53¾	10	–	–	14.90 lbs.	1.4
	65N4710MPA	580	¾	47¾	10	–	–	14.34 lbs.	1.3

- Provides user privacy and conceals electrical components on freestanding applications
- Modesty panels can expand the full width or more narrow; see page 333 for more specification details
- Resin color is 1677 Frosted

TFL MODESTY PANELS

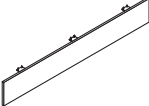
	65N7110MPLL	\$ 440	¾	71¾	10	–	–	19.81 lbs.	1.8
	65N6510MPLL	418	¾	65¾	10	–	–	18.30 lbs.	1.7
	65N5910MPLL	395	¾	59¾	10	–	–	17.53 lbs.	1.5
	65N5310MPLL	385	¾	53¾	10	–	–	14.90 lbs.	1.4
	65N4710MPLL	370	¾	47¾	10	–	–	14.34 lbs.	1.3

- Provides user privacy and conceals electrical components on freestanding applications
- Modesty panels can expand the full width or more narrow; see page 333 for more specification details
- Grain direction runs with the width of the modesty

NAVIYD

PRODUCT SPECIFICATIONS

- Tackable fabric screen with frame
- Ships with attachment hardware
- Pairable with the standard height adjustable desk only
- See page 333 for additional specification information

TO ORDER, SPECIFY:

1. Model Number
2. Frame Paint Color
3. Fabric Grade
4. Fabric Color

SAMPLE MODEL NUMBER:

65N7129PVSCPF 501 A 8608

- See pages 335-337 for all options available in Naviyd

MODEL NO./DESCRIPTION	LIST PRICE		DIMENSIONS					CARTONED WEIGHT	CUBIC FEET
	GRADE A	GRADE B/COM	D	W	H	A	KW		
29" HIGH FABRIC PRIVACY SCREEN WITH FRAME									
65N7129PVSCPF	\$ 1458	\$ 1498	1 $\frac{3}{16}$ "	71 $\frac{3}{16}$ "	29"	—	—	50.0 lbs.	10.6
65N6529PVSCPF	1392	1432	1 $\frac{3}{16}$ "	65 $\frac{3}{16}$ "	29"	—	—	46.5 lbs.	9.8
65N5929PVSCPF	1329	1369	1 $\frac{3}{16}$ "	59 $\frac{3}{16}$ "	29"	—	—	43.0 lbs.	8.9
65N5329PVSCPF	1258	1298	1 $\frac{3}{16}$ "	53 $\frac{3}{16}$ "	29"	—	—	39.5 lbs.	8.1
65N4729PVSCPF	1191	1231	1 $\frac{3}{16}$ "	47 $\frac{3}{16}$ "	29"	—	—	36.0 lbs.	7.3
65N4129PVSCPF	1162	1202	1 $\frac{3}{16}$ "	41 $\frac{3}{16}$ "	29"	—	—	35.0 lbs.	2.5
65N3529PVSCPF	1132	1172	1 $\frac{3}{16}$ "	35 $\frac{3}{16}$ "	29"	—	—	31.0 lbs.	2.2

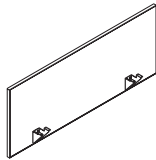

- 29" H privacy screens are 21" above and 6 $\frac{1}{2}$ " below the worksurface
- Privacy screens are not applicable on extended height or C-leg bases due to tipping hazards and interference with understructures
- Attaches to the underside of the worksurface to provide space division and privacy above and below worksurface
- See page 333 for additional details
- Attachment brackets are painted to match the color of the frame

20" HIGH FABRIC PRIVACY SCREEN WITH FRAME

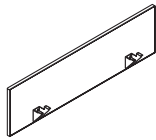

MODEL NO./DESCRIPTION	LIST PRICE		DIMENSIONS					CARTONED WEIGHT	CUBIC FEET
	GRADE A	GRADE B/COM	D	W	H	A	KW		
20" HIGH FABRIC PRIVACY SCREEN WITH FRAME									
65N7120PVSCPF	\$ 1256	\$ 1296	1 $\frac{3}{16}$ "	71 $\frac{3}{16}$ "	20"	—	—	39.0 lbs.	7.8
65N6520PVSCPF	1196	1236	1 $\frac{3}{16}$ "	65 $\frac{3}{16}$ "	20"	—	—	37.0 lbs.	7.2
65N5920PVSCPF	1132	1172	1 $\frac{3}{16}$ "	59 $\frac{3}{16}$ "	20"	—	—	34.0 lbs.	6.6
65N5320PVSCPF	1068	1108	1 $\frac{3}{16}$ "	53 $\frac{3}{16}$ "	20"	—	—	31.0 lbs.	6.0
65N4720PVSCPF	1004	1044	1 $\frac{3}{16}$ "	47 $\frac{3}{16}$ "	20"	—	—	28.0 lbs.	5.4
65N4120PVSCPF	975	1015	1 $\frac{3}{16}$ "	41 $\frac{3}{16}$ "	20"	—	—	27.0 lbs.	1.8
65N3520PVSCPF	946	986	1 $\frac{3}{16}$ "	35 $\frac{3}{16}$ "	20"	—	—	24.0 lbs.	1.6

- 20" H privacy screens are 12" above and 6 $\frac{1}{2}$ " below the worksurface
- Privacy screens are not applicable on extended height or C-leg bases due to tipping hazards and interference with understructures
- Attaches to the underside of the worksurface to provide space division and privacy above and below worksurface
- See page 333 for additional details
- Attachment brackets are painted to match the color of the frame